

DRAFT FINAL REPORT

# Ultra High-Speed Ground Transportation Study

*Prepared for*

Washington State Department of  
Transportation



December 2017

*Prepared by*



CH2M HILL, Inc.  
2020 SW Fourth Avenue, 3rd Floor  
Portland, OR 97201





## Foreword

I am confident and optimistic about Washington State and the Cascadia Innovation Corridor. Our region is characterized by a rapidly growing population with shared values, booming twenty-first century industries and an appetite for innovation. To fully realize our growth potential, we continue to look for ways to improve economic, social and environmental well-being, especially across our borders. I believe people are passionate and hungry for options that would maintain our quality of life in the Pacific Northwest.

Our prosperity depends in part on our ability to respond to rising congestion, shifts in population and workforce, and alternative transportation needs. Ultra high-speed ground transportation is one way to address these issues. With an ultra high-speed ground transportation system, people could travel from Seattle to Vancouver BC in less than an hour. Such a system would greatly improve connectivity, encourage smart development and enhance business opportunities. As airports and roadways become increasingly congested, a new ultra high-speed ground transportation system would provide travelers with an alternative transportation mode, which would not only bypass traffic but also reduce carbon emissions.

There is much work to do. This study is an important first step in examining the feasibility of an ultra high-speed ground transportation system across Cascadia. Indeed, there will be costs to developing such a system. However, there are perhaps even greater costs to rising congestion and a do-nothing approach. Moving forward, public and private sectors in Washington, Oregon, and British Columbia will need to continue to work together to explore innovative transportation options that derive cross-border benefits.

This study is the product of the Cascadia Innovation Corridor conference, in which Washington State and British Columbia came together to explore joint partnerships, including opportunities for faster, more reliable transportation for the Cascadia megaregion. I am confident that with this tangible example of collaboration, we can better realize and seize the opportunities available to us and work to further enhance our connectivity and quality of life in the Pacific Northwest.

—Jay Inslee, Governor





# Acknowledgements

*The Washington Department of Transportation would like to acknowledge and thank the many partners, stakeholders, and staff that supported this study with special thanks to the Washington State Legislature, the Office of Governor Inslee, Federal Railroad Administration, Microsoft, Washington Building Trades, the Advisory Group members and the Vancouver Economic Commission for hosting the October 25th Advisory Group meeting and Prosper Portland for hosting the December 7th Advisory Group meeting.*



# Contents

- Foreword.....i**
- Acknowledgements.....iii**
- Contents.....v**
- Acronyms and Abbreviations..... ix**
- Introduction.....1-1**
  - 1.1 Study Background ..... 1-1
  - 1.2 Study Purpose and Approach ..... 1-1
- Vision for Ultra High-Speed Ground Transportation in the Cascadia Megaregion.....2-1**
  - 2.1 Impetus for Ultra High-Speed Ground Transportation..... 2-1
  - 2.2 Cascadia Megaregion Context ..... 2-3
    - 2.2.1 Population and Employment Profile..... 2-3
    - 2.2.2 Transportation Network ..... 2-4
- Technology Evaluation .....3-1**
  - 3.1 High-Speed Rail (Steel Wheel) ..... 3-1
    - 3.1.1 Future Development of High-Speed Rail ..... 3-2
  - 3.2 Magnetic Levitation (Maglev) ..... 3-2
    - 3.2.1 Electromagnetic Suspension ..... 3-2
    - 3.2.2 Electrodynamic Suspension ..... 3-3
    - 3.2.3 Future Development..... 3-4
  - 3.3 Hyperloop ..... 3-5
    - 3.3.1 Hyperloop Case Uses ..... 3-5
    - 3.3.2 Current Development and Studies ..... 3-6
    - 3.3.3 Hyperloop Outlook and Recommendations ..... 3-7
- Study Corridor Concepts.....4-1**
  - 4.1 Corridor Concept Development..... 4-1
  - 4.2 Concept Corridors..... 4-3
  - 4.3 Connecting Corridor Considerations..... 4-9
    - 4.3.1 East-West Corridor Description ..... 4-9
    - 4.3.2 North-South California Corridor Description ..... 4-10
- Corridor Analysis.....5-1**
  - 5.1 Evaluation Methodology..... 5-1
    - 5.1.1 CONNECT Sketch Planning Tool ..... 5-1
    - 5.1.2 Screening Process ..... 5-3
  - 5.2 Feasibility for Future Federal Funding Availability ..... 5-4
    - 5.2.1 Operating Recovery Ratio and Total Recovery Ratio..... 5-5
    - 5.2.2 Benefit/Cost Analysis..... 5-7
    - 5.2.3 Other Indicators of Feasibility..... 5-8
  - 5.3 Demand and Ridership..... 5-8
    - 5.3.1 Primary Corridor – Portland to Vancouver ..... 5-9
    - 5.3.2 Connecting Corridor – Seattle to Spokane ..... 5-10
  - 5.4 Cost Estimates..... 5-10
    - 5.4.1 Operating Cost Recovery ..... 5-11

5.4.2	Total Cost Recovery .....	5-11
5.4.3	Total Capital Investment.....	5-12
5.4.4	CONNECT Results Summary.....	5-13
<b>Implementing Ultra High-Speed Ground Transportation .....</b>		<b>6-1</b>
6.1	Funding and Financing .....	6-1
6.2	Overview of Funding and Financing Models.....	6-1
6.2.1	Overview of Public-Private Partnerships .....	6-2
6.2.2	United States Funding and Financing Programs.....	6-3
6.2.3	Canadian Funding and Financing Programs .....	6-6
6.2.4	International Funding and Financing Models .....	6-8
6.2.5	Summary of Learned Lessons.....	6-11
6.3	Cross-Border Issues.....	6-12
6.4	U.S.– Canadian Cross-Border Arrangements .....	6-13
6.4.1	Amtrak Cascades Rail Service .....	6-14
6.4.2	St. Lawrence Seaway (Joint Commission).....	6-14
6.4.3	Ferry Services Between Washington State and British Columbia .....	6-15
6.4.4	Coach Services Between Washington State and British Columbia .....	6-15
6.5	Selected International Examples of Governance Models for High-Speed Rail .....	6-15
6.5.1	London–Paris High-Speed Rail .....	6-15
6.5.2	Kuala Lumpur–Singapore High-Speed Rail.....	6-16
6.5.3	France-Spain New High-Speed Line under a P3 Model: Perpignan to Figueres .....	6-18
6.6	Categories of Governance Models: Initial Issues.....	6-18
6.6.1	P3/Private Finance .....	6-18
6.6.2	Single Country Delivery and Management for Operations .....	6-19
6.6.3	Joint Commission or Joint Project Company .....	6-19
6.6.4	Vertical Separation Models .....	6-19
6.7	Study Findings.....	6-20
<b>Next Steps - Recommendations.....</b>		<b>7-1</b>
7.1	Cascadia Transportation System.....	7-1
7.2	Ridership .....	7-1
7.3	Governance and Economic Framework.....	7-1
7.4	Funding and Financing .....	7-2
7.5	Stakeholder Involvement.....	7-2
7.6	Short-Term Rail Planning Consistent with the Longer-Term UHSGT program .....	7-2

**Tables**

Table 2-1.	Existing Travel Choices Seattle to Vancouver .....	2-6
Table 2-2.	Existing Travel Choices Portland to Seattle.....	2-6
Table 3-1.	Types of Ultra High-Speed Ground Transportation Systems .....	3-1
Table 3-2.	Length of the World’s High-Speed Rail Network by 2035 .....	3-2
Table 3-3.	Length of the Maglev Lines .....	3-5
Table 4-1.	UHSGT Corridor Screening Criteria .....	4-2
Table 4-2.	Key Assumptions for Conceptual Corridors (For study purposes only) .....	4-4
Table 5-1.	Operating Recovery Ratio for 2035.....	5-6
Table 5-2.	Operating Recovery Ratio for 2055.....	5-6



Table 5-3. Total Recovery Ratio for 2035..... 5-7

Table 5-4. Total Recovery Ratio for 2055..... 5-7

Table 5-5. 2035 CONNECT Ridership Results ..... 5-8

Table 5-6. 2055 CONNECT Ridership Results ..... 5-9

Table 5-7. Network Ridership Breakdown ..... 5-10

Table 5-8. 2035 CONNECT Cost Estimates ..... 5-10

Table 5-9. 2055 CONNECT Cost Estimates ..... 5-11

Table 6-1. United State Funding and Financing Programs and Eligibility ..... 6-7

Table 6-2. CIB Investment in Ultra High-Speed Ground Transportation ..... 6-8

Table 6-3. International High-Speed Rail Case Studies ..... 6-9

Table 6-4. Description of Alternative Multi-State Governance Models ..... 6-12

**Figures**

Figure 2-1. Professional Network Connections of Seattle and Vancouver Residents ..... 2-1

Figure 2-2. Cascadia Megaregion..... 2-3

Figure 2-3. Portland, Seattle, and Vancouver MSAs Base and Forecast Population ..... 2-4

Figure 2-4. Amtrak Cascades Route in the Cascadia Megaregion ..... 2-5

Figure 2-5. Amtrak Cascades Passenger Miles..... 2-5

Figure 3-1. Electromagnetic Suspension..... 3-3

Figure 3-2. Schematic Diagram of EDS Maglev System ..... 3-3

Figure 3-3. Shanghai Maglev Train..... 3-4

Figure 3-4. Chuo Shinkansen Map ..... 3-4

Figure 4-1. Corridor Concept 1A ..... 4-6

Figure 4-2. Corridor Concept 2..... 4-7

Figure 4-3. Corridor Concept 4..... 4-8

Figure 4-4. East-West Corridor ..... 4-9

Figure 5-1. Round 1 Ridership Comparison ..... 5-3

Figure 5-2. Round 2 Total Recovery Ratio Frequency Sensitivity ..... 5-4

Figure 5-3. Capital Investment Ranges by Corridor ..... 5-12

Figure 6-1. Financing and Delivery models - Distribution of Risk for Various Project Delivery Options ... 6-2

Figure 6-2. Governance and Regulatory Framework for London-Paris HSR Passenger Services ..... 6-16

Figure 6-3. Regulatory Framework for Kuala Lumpur–Singapore HSR line ..... 6-17



# Acronyms and Abbreviations

AssetsCo	assets company
BC	British Columbia
BCA	Benefit/Cost Analysis
CapEx	capital expenditure
CBD	central business district
CBSA	Core Based Statistical Area
CIB	Canada Infrastructure Bank
CIQ	Customs, Immigration and Quarantine
CONNECT	Conceptual Network Connections Tool
EDS	electrodynamic suspension
EMS	electromagnetic suspension
FAST	Fixing America's Surface Transportation
FRA	Federal Railroad Administration
HSGT	high-speed ground transportation
HSR	high-speed rail
IEP	Intercity Express Program
IGC	Inter-Governmental Commission
INFRA	Infrastructure for Rebuilding America
InfraCo	infrastructure company
KL	Kuala Lumpur
km/h	kilometers per hour
LRT	light rail train
maglev	magnetic levitation
mph	miles per hour
MSA	metropolitan statistical area
NEC	Northeast Corridor
O&M	operation and maintenance
OpCo	operating company
OpEx	operating expenditure
ORR	Office of Rail and Road
P3	public-private partnership
PABs	Private Activity Bonds
PNWRC	Pacific Northwest Rail Corridor

ACRONYMS AND ABBREVIATIONS

RRIF	Railroad Rehabilitation Improvement and Financing
SC maglev	superconducting maglev
TIFIA	Transportation Infrastructure Finance and Innovation Act
TIGER	Transportation Investment Generating Economic Recovery
UHS GT	ultra high-speed ground transportation
UK	United Kingdom
UPRR	Union Pacific Railroad
WSDOT	Washington State Department of Transportation

# Introduction

## 1.1 Study Background

In September 2016, the Emerging Cascadia Innovation Corridor Conference invited leaders from British Columbia and Washington to foster creation of a new global hub for innovation and economic development. Business and government leaders explored the potential for joint partnerships in education, transportation, university research, and human capital, among others. Leaders from both sides of the U.S.-Canadian border acknowledged the importance of developing an interconnected, competitive economic region and identified actions to further that vision.

At the conference, Washington Governor Jay Inslee and British Columbia Premier Christy Clark signed a formal agreement<sup>1</sup> committing the two governments to work together to foster collaboration and innovation. The agreement outlines formal steps the two governments will take to partner in several areas, including transportation.

The agreement between the two governments has already resulted in meaningful collaboration, with Governor Inslee and the Washington Legislature taking steps to foster greater economic interconnectivity in the region by initiating an evaluation of the potential for ultra high-speed ground transportation between Vancouver, British Columbia, and Portland, Oregon. The Washington State Legislature appropriated \$300,000 to update the Washington State Department of Transportation's (WSDOT) 1992 *High Speed Ground Transportation Study* and analyze the potential for an ultra high-speed ground transportation (UHS GT) alignment and potential stop locations between Vancouver and Portland. Furthermore, in response to the Washington State Legislature's budget proviso to assess the viability of an ultra high-speed rail corridor, Premier Clark submitted a letter of support for the project.

This report summarizes the findings of the evaluation and includes the following sections:

1. Introduction
2. Vision for Ultra High-Speed Ground Transportation in the Cascadia Megaregion
3. Technology Evaluation
4. Study Corridor Concepts
5. Corridor Analysis
6. Implementing Ultra High-Speed Ground Transportation
7. Next Steps

## 1.2 Study Purpose and Approach

A rapidly growing economy and population characterize the Cascadia megaregion,<sup>2</sup> encompassing Vancouver, BC; Seattle, Washington; and Portland, Oregon. Cascadia shares similar values, skilled workforces, and an appetite for innovation, including advancing economic and social interconnectivity. Enhanced interconnectivity would allow Cascadia to better manage the megaregion's growth potential and maximize public transportation benefits. The purpose of the study is to examine (at an initial high

---

<sup>1</sup> Business Council of British Columbia, 2016, "Providence of British Columbia and Washinton Memorandum of Understanding", <http://www.bcbc.com/news-releases/2016/cascadiarelease>.

<sup>2</sup> Megaregions are networks of metropolitan regions with shared economies, infrastructure and natural ecosystems. There are 11 emerging megaregions in the U.S. They include the Northeast, Florida, Piedmont Atlantic, Great Lakes, Gulf Coast, Texas Triangle, Arizona Sun Corridor, Front Range, Southern California, Northern California, and Cascadia.

level) potential technology, organizational, and financing and funding alternatives as well as possible economic benefits to the megaregion from providing access to major employment hubs and growing industries through UHSGT. This study identifies opportunities to increase economic and social interconnections within the megaregion. It examines, at a high level, the potential for development of UHSGT between Portland, Seattle and Vancouver, with a possible passenger rail connection to Spokane, Washington, and extension of high-speed rail south of Portland to Sacramento, California to connect to the proposed California high-speed rail network. In this study, ultra high-speed is defined as a maximum operating speed of  $\geq 250$  miles per hour (mph) (402 km/h).

WSDOT identified five conceptual north-south corridors (Portland, Seattle, Vancouver, and potential station locations in-between), one east-west connecting corridor (from Seattle to Spokane following the Stampede Pass Line), and a conceptual connecting ultra high-speed rail corridor from Portland to Sacramento to evaluate. The technologies evaluated include high-speed (steel wheel) rail and maglev, with additional consideration of hyperloop. The project team used the Federal Railroad Administration's (FRA) Conceptual Network Connections Tool<sup>3</sup> (CONNECT) to estimate the identified rail corridors and network performance for public benefits. CONNECT provides corridor analysis outputs for three high-performance intercity passenger rail service tiers that they generally define as:

- **Core Express** – frequent trains at 125-250+ mph (201-402+ km/h) in the nation's densest and most populous regions
- **Regional** – 90-125 mph (145-201 km/h) between mid-sized and large cities
- **Emerging** – up to 90 mph (145 km/h) connecting communities to passenger rail network and providing foundation for future corridor development

For the purposes of this study, the conceptual primary, north-south corridors are considered "Core Express", the east/west connecting corridor is considered "Emerging" and the connecting corridor from Portland to Sacramento is considered "Core Express".

In addition to the technical analysis of the conceptual corridors, WSDOT convened an Advisory Group comprised of both public and private sector subject matter experts in a range of topics, to provide input and comment on planning level inputs and draft conclusions and recommendations. The Advisory Group met four times over a period of six months, including convening one meeting in Vancouver, Seattle, and Portland, which are the three largest cities in the conceptual corridor. The following stakeholders that participated in the Advisory Group are listed below.

- |   |                                       |
|---|---------------------------------------|
| • Association of Washington Business          | • Oregon Department of Transportation |
| • British Columbia Ministry of Transportation | • Oregon Metro                        |
| • Business Council of British Columbia        | • Portland Business Alliance          |
| • City of Portland                            | • Prosper Portland                    |
| • City of Seattle                             | • Puget Sound Regional Council        |
| • City of Surrey                              | • Seattle Chamber of Commerce         |
| • City of Vancouver                           | • Snohomish County Executive          |
| • Fast Track Washington                       | • Sound Transit                       |
| • Forth                                       | • Tourism Vancouver                   |
| • Futurewise                                  | • TransLink                           |
| • Microsoft                                   | • Transport Canada                    |
| • Office of King County Executive             | • Transportation Choices              |

---

<sup>3</sup> CONceptual NETwork Connections Tool or CONNECT is a high level intercity passenger rail sketch planning tool that estimates overall performance of user-define corridors and networks. It is intended for early-stage planning processes to compare corridors and enables a user to describe potential high-performance rail network at a coarse level, estimate the financial and operational performance of the network, develop high level service plans, and generate operational data. CONNECT is discussed in greater detail in Section 5 of this report.

- U.S. Consulate Vancouver
- University of Washington
- Utilities and Transportation Commission
- Vancouver Economic Commission
- Washington Building Trades
- Washington CleanTech Alliance
- Washington Department of Commerce
- Washington Governor's Office
- Washington Legislative Staff
- Washington Department of Transportation
- YVR

This study addresses the following elements as identified by the Washington State Legislature<sup>4</sup>:

- An update to the 1992 WSDOT feasibility study based on UHSGT
- An analysis of corridor alignment and station stops, including connecting to Eastern Washington and the high-speed rail system in California
- Demand forecasts, economic feasibility, technological options, institutional arrangements, and financing mechanisms
- Land use, right-of-way, and environmental implications
- Compatibility with other regional transportation plans and impacts to other modes, including air travel
- Required speed, safety, access, and frequency specifications

---

<sup>4</sup> [2017 Engrossed Senate Bill 5096, Section 222.](#)





# Vision for Ultra High-Speed Ground Transportation in the Cascadia Megaregion

## 2.1 Impetus for Ultra High-Speed Ground Transportation

Geographic and economic trends indicate that the next 50 years will be defined by the emergence of megaregions both nationally and internationally. America 2050, an infrastructure research and policy initiative, identified 11 megaregions in the U.S. that share similar characteristics, including corridors that range from 200 to 600 miles (322 to 966 km) in length, where roughly three-fourths of the nation's population lives, and an even greater percentage of its gross domestic product is produced.<sup>5</sup>

Vancouver, Seattle, and Portland share many commonalities, including an educated and skilled workforce, similar public policies, academic institutions, and a culture of innovation. However, despite their relative proximity, these three cities are economically disconnected.<sup>6</sup> In Vancouver and Seattle there are only a few companies that operate in both cities and most have a significant presence in one and a smaller satellite outpost in the other.

Individuals from Vancouver and Seattle are not very connected and the workforce does not participate between the two cities. According to LinkedIn, there are few interconnections between members from Vancouver and Seattle with connections between members only representing less than 1% of their total connections. Figure 2-1 illustrates the professional network of Vancouver and Seattle residents using LinkedIn data. Members from Vancouver have greater connectivity with members from San Francisco while Seattle member is more interconnected with Atlanta than to Vancouver.

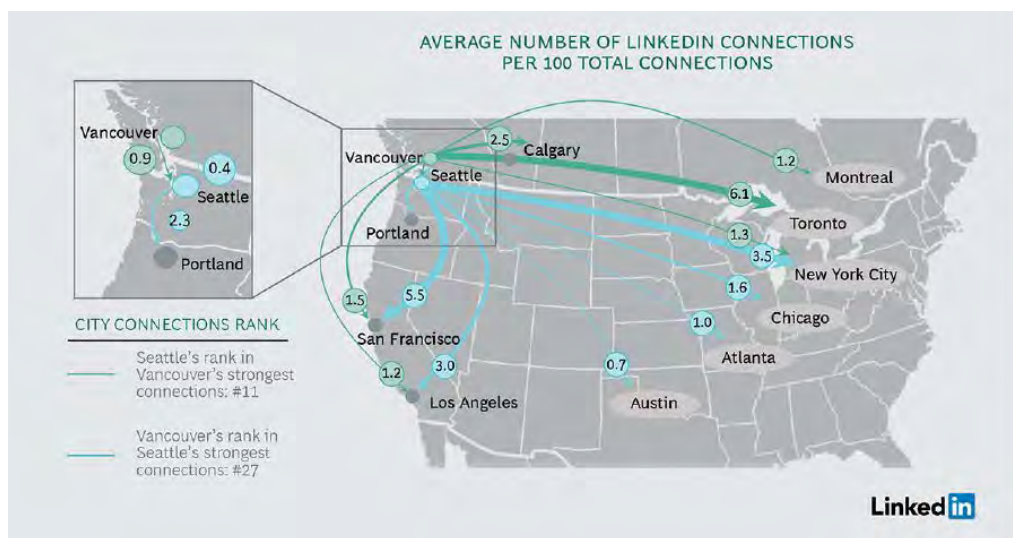

Figure 2-1. Professional Network Connections of Seattle and Vancouver Residents

Source: LinkedIn Economic Graph data.

<sup>5</sup> Hagler, Y., and P. Todorovich, 2009, Where High-Speed Rail Works Best, <http://www.america2050.org/pdf/Where-HSR-Works-Best.pdf>.

<sup>6</sup> Westrup, J., Andersen, P., and St. Clair, W., 2016, *Better Together: Th Cascadia Innovation Corridor Opportunity*. BCG Perspectives.

Megaregions are quickly representing a greater share of the international economy. For example, 300 metro areas represent 10 percent of the global population and generate approximately 50 percent of global GDP<sup>7</sup>. Although, Vancouver and Seattle are economically disconnected there is an opportunity for the two cities to collaborate toward greater integration that could generate increased economic and social gains for both metro areas.

UHS GT systems are an efficient transportation mode to promote greater economic interconnectivity and innovation within megaregions by substantially enhancing connection between people and goods and services, which promotes trade and tourism, and expands travel, housing, and employment options. Centralized and interconnected transportation hubs provide opportunities to generate economic development and jobs for businesses within a corridor. UHS GT in the Cascadia megaregion can provide a fast and reliable transportation mode that is essential to supporting the economic and social interconnectivity identified in the agreement between Governor Inslee and Premier Clark.

In addition to economic development, several needs or drivers form the basis and rationale for Washington State and its partner stakeholders to study the potential for UHS GT in Cascadia. These include (but are not limited to) the following:

- Robust population and economic growth in the Cascadia megaregion that encompasses the Vancouver, BC, to Portland, Oregon, travel market will substantially increase travel demand and generate additional congestion that further reduces automobile, transit, and air travel reliability using existing and committed transportation infrastructure.
- Automobile collisions and the resultant injuries, loss of life, and property damage decrease the safety of driving as a transportation mode and contribute to non-recurring congestion that reduces travel time reliability and increases delays for travelers.
- Current intercity passenger rail service operating capacity and speed constraints limit regional mobility, and economic development and global competitiveness.
- Declining air quality and greater climate instability associated with greenhouse gas emissions from increased travel demand and congestion require more environmentally sustainable modes of travel.
- Natural hazards, such as flooding and landslides, are common in the Cascadia megaregion and can result in prolonged closure or disruption to major transportation infrastructure including Interstate 5 and the BNSF/Amtrak rail line, with no other viable route options available.
- Cumulatively, these driving factors negatively impact quality of life for residents, businesses, and visitors of the Cascadia megaregion.

America 2050 developed six criteria to identify corridors in the U.S. where high-speed rail would be most successful. The criteria include metropolitan size, distance, transit connections, economic productivity, congestion, and megaregion.<sup>8</sup> Cities located in one of the 11 megaregions identified by America 2050 are more likely to be part of a network of interconnected cities with the appropriate density to support high-speed rail systems. The Cascadia megaregion emerged as one of the 11 megaregions with the appropriate characteristics to support high-speed rail.

---

<sup>7</sup> Westrup, J., Andersen, P., and St. Clair, W., 2016, *Better Together: Th Cascadia Innovation Corridor Opportunity*. BCG Perspectives.

<sup>8</sup> Hagler, Y., and P. Todorovich, 2009, Where High-Speed Rail Works Best, <http://www.america2050.org/pdf/Where-HSR-Works-Best.pdf>.

## 2.2 Cascadia Megaregion Context

### 2.2.1 Population and Employment Profile

The Cascadia megaregion spans approximately 466 miles (750 km) from Vancouver, BC to Eugene, Oregon. It includes two medium-sized metropolitan areas (Portland and Seattle) and one larger metropolitan area (Vancouver). Portland and Seattle are relatively compact with consistent medium density from their urban core through their metropolitan fringe. Vancouver is Canada's third largest metro region with more than two million people.<sup>9</sup> **Figure 2-1** illustrates the Cascadia megaregion.



Figure 2-2. Cascadia Megaregion

Source: <http://www.america2050.org/megaregions.html>

Seattle and Portland have relatively large central business districts, especially when compared with other U.S. metros with much larger populations, such as Los Angeles, Houston, and Dallas. For example, in 2010, Seattle's central business district (CBD) ranked ninth in the nation and supported 700,000 jobs within 10 miles of the city center. Portland's CBD ranked 14th in the nation and supported 650,000 jobs within 10 miles (16 km) of downtown.<sup>10</sup> Vancouver, BC, supports a similar number of jobs with 600,000 jobs being located within 10 miles (16 km) of its CBD.

The populations of the three largest metropolitan areas in the Cascadia megaregion are growing and at a faster rate than anticipated by demographic forecasters. In 1990, the populations of Portland, Seattle, and Vancouver, BC, metropolitan statistical areas (MSAs) were forecast to reach 2.0, 3.4, and 2.3 million people, respectively by 2020. As of 2015, each MSA had exceeded the 2020 forecasts for population growth made in 1990. In 2015, the three metro regions had a combined total population of approximately 8.4 million people. Rapid population growth is expected to continue; each metro area is expected to add around 1 million people each, with Seattle experiencing the greatest levels of growth

<sup>9</sup> Todorovich, P. and Y. Hagler, 2011, *High Speed Rail in America*.

<sup>10</sup> Todorovich, P. and Y. Hagler, 2011, *High Speed Rail in America*.

and reaching 5.2 million people by 2040. **Figure 2-3** illustrates the base and forecast population for the Portland, Seattle, and Vancouver MSAs.

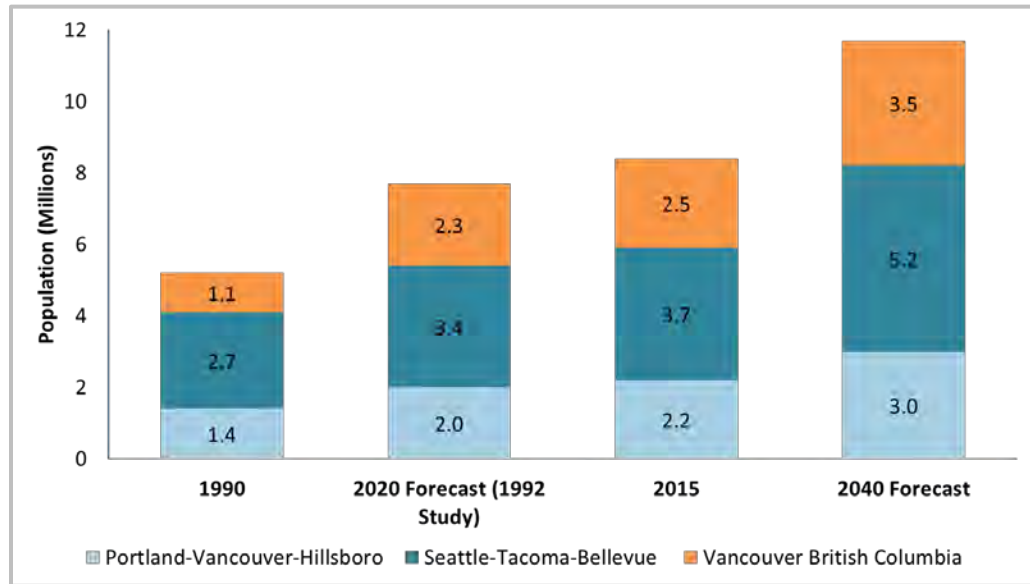

**Figure 2-3. Portland, Seattle, and Vancouver MSAs Base and Forecast Population**

*Source: CH2M calculations (Washington Department of Transportation 1992 High-Speed Ground Transportation Study, Washington Office of Financial Management population projections, Oregon Department of Administrative Services and Metro Portland population projections, Metro Vancouver population projections, and U.S. Census Bureau).*

## 2.2.2 Transportation Network

### 2.2.2.1 Rail and Transit Service

The Pacific Northwest Rail Corridor (PNWRC) is one of 11 federally-designated high-speed rail corridors in the U.S. As illustrated in **Figure 2-4**, the 461-mile (742-kilometer) PNWRC serves the most densely populated areas of the Cascadia megaregion, linking Vancouver, BC, to Seattle, Portland, and Eugene. BNSF Railway owns most of the existing PNWRC railroad infrastructure in British Columbia, in Washington,<sup>11</sup> and in Oregon north of Union Station in Portland. Union Pacific Railroad (UPRR) owns the existing PNWRC railroad infrastructure in Oregon south of Union Station. Freight and passenger trains operated by BNSF Railway, UPRR, Oregon Pacific, Portland Terminal Railroad, Willamette Valley Rail, Portland & Western Railroad, and Amtrak currently use BNSF Railway and UPRR trackage that also serves as the PNWRC. With funding from the states of Washington and Oregon, Amtrak operates the Cascades passenger rail service, which consists of 11 trains operating in the Pacific Northwest daily with stops in 18 cities. The service includes six daily round trips between Seattle and Portland; two daily round trips between Seattle and Vancouver, BC; and two daily round trips between Portland and Eugene. Operating the Amtrak Cascades trains requires partnerships between Washington, Oregon, British Columbia, Amtrak, three railroads, international customs and border control agencies, and train and locomotive manufacturers.



**Figure 2-4. Amtrak Cascades Route in the Cascadia Megaregion**

*Source: WSDOT*

<sup>11</sup> Except the Point Defiance Bypass, which is owned by Sound Transit.

Amtrak Cascades is funded by ticket sales and by subsidies provided by WSDOT and the Oregon Department of Transportation.

In 2010, under the American Recovery and Reinvestment Act, also known as the ARRA program, the U.S. Department of Transportation awarded the State of Washington over \$800 million in infrastructure and equipment grants to improve the reliability of the PNWRC, add two additional frequencies between Portland and Seattle and to reduce travel time between those two cities by 10 minutes. As of the publication of this report, those new services and improvements were about to be placed in service.

Ridership has more than quadrupled on the corridor, from 200,000 in 1994 to approximately 817,000 in 2016. As illustrated in **Figure 2-5**, the Seattle to Portland and Seattle to Vancouver segments represented the largest share of riders with 441,000 and 188,000 riders in 2016, respectively. The Portland to Eugene segment had the smallest share of total riders in 2016 with 69,000 riders.<sup>12</sup>

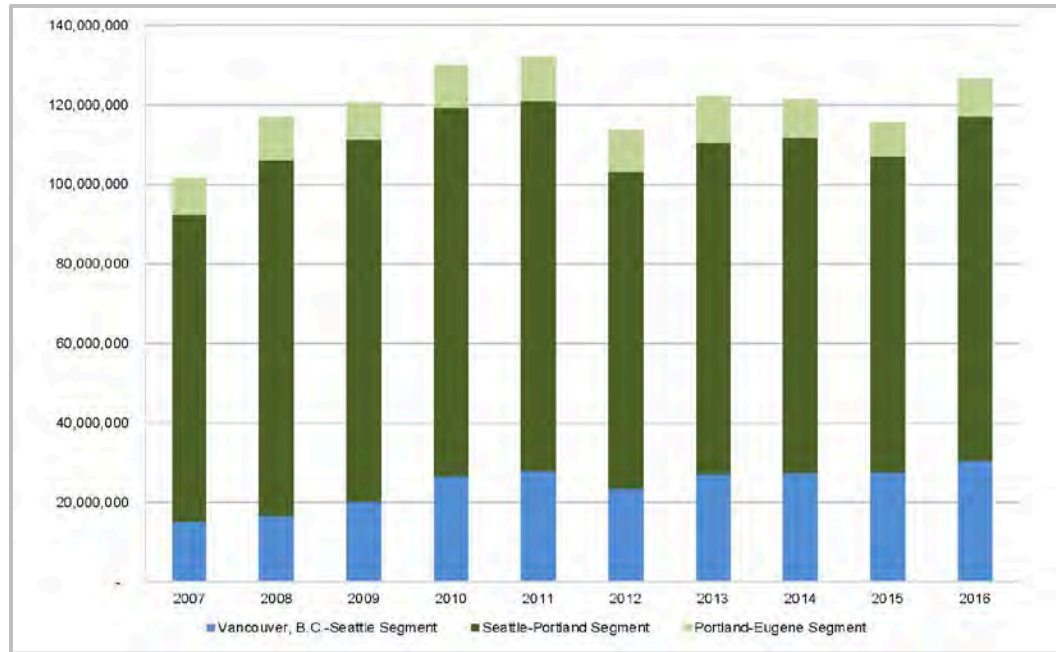

Figure 2-5. Amtrak Cascades Passenger Miles

Source: WSDOT

Regional transit systems in Vancouver, Seattle, and Portland have extensive network connectivity and service. Vancouver's transit network, planned and managed by TransLink, is one of the most extensive for a large metropolitan region in North America. TransLink operates SkyTrain, the oldest and one of the longest automated driverless light rapid transit systems in the world. It consists of three primary lines: Expo, Millennium, and Canada. In December 2016, TransLink officially opened the Evergreen Extension, an extension of the Millennium Line, for operation.

In Seattle, Sound Transit plans, builds, and operates express bus, light rail and commuter train services in the urban areas of King, Pierce, and Snohomish counties. The Sounder train is a regional commuter rail service operated by BNSF on behalf of Sound Transit. Trains travel from Seattle north to Everett and south to Lakewood.

TriMet provides bus, light rail, and commuter rail transit services in the Portland metropolitan area. The Portland region's light rail system is the largest stand-alone light rail system in the nation by ridership. According to the America 2050 report, *High Speed Rail in America*, "nearly one-quarter of the population

<sup>12</sup> WSDOT, 2016, Amtrak Cascades: 2016 Performance Data Report.

and 42 percent of the employment within 25 miles (40 km) of downtown Portland is located accessible to a transit station.”<sup>13</sup> In contrast, at the time this report was written in 2011, 7 percent of Seattle’s population and 10 percent of the employment is accessible by transit.

The existing travel choices in Cascadia include air, rail, automobile, and bus service. **Tables 2-1** and **2-2** illustrate the distance, travel time, and price for each mode for the Seattle to Vancouver and Portland to Seattle segments. Travel distances are greater in the Portland to Seattle segment than the Seattle to Vancouver segment for all travel modes. However, for both segments Amtrak Cascades travels the farthest and has the highest travel time. Air travel for both segments is most competitive in terms of travel time across all modes, but is also the most expensive travel option.

Table 2-1. Existing Travel Choices Seattle to Vancouver

Mode	Distance (miles)	Travel Time	Price
Air	119 (192 km)	0:55	\$164
Amtrak Cascades	157 (253 km)	4:30	\$63 - \$98 <sup>14</sup>
Automobile	141 (227 km)	2:41	\$75
Bus	141 (227 km)	4:08	\$45

Source: AECOM calculations (Expedia flight data, Amtrak schedules and pricing, Google maps and IRS mileage; and Greyhound bus schedules and ticket pricing)

Table 2-2. Existing Travel Choices Portland to Seattle

Mode	Distance (miles)	Travel Time	Price
Air	130 (209 km)	0:50	\$175
Amtrak Cascades	177 (285 km)	3:40	\$35 - \$64 <sup>15</sup>
Automobile	173 (278 km)	3:14	\$92
Bus	173 (278 km)	3:35	\$20

Source: AECOM calculations

The distance between Portland and Seattle is less than 200 miles (322 km), which is at the low end of the range for distances between destinations that support a robust air market.<sup>16</sup> In addition, the corridor has significant highway congestion. In 2016, the three largest metropolitan cities, Vancouver, Seattle, and Portland, experienced an average of 142 hours of delay annually per driver.<sup>17</sup> This total is significantly greater than the 107 average annual hours of delay experienced by the largest metropolitan areas in the travel corridors when compared with Texas Central Partners High-Speed (Dallas and Houston) and the Brightline Intercity (Miami and Orlando) rail projects.<sup>18</sup>

<sup>13</sup> Todorovich, P. and Y. Hagler, 2011, *High Speed Rail in America*.

<sup>14</sup> Price of business class ticket.

<sup>15</sup> Price of business class ticket.

<sup>16</sup> Todorovich, P. and Y. Hagler, 2011, *High Speed Rail in America*.

<sup>17</sup> Annual hours of delay are the extra travel time during peak hours compared to an hour of driving during free flow conditions, multiplied by 230 working days per year.

<sup>18</sup> Source: Analyst derived using data from [https://www.tomtom.com/en\\_gb/trafficindex](https://www.tomtom.com/en_gb/trafficindex)

# Technology Evaluation

Three technologies could potentially meet the operating speed requirement of >250 mph (402 km/h) for UHSGT:

- High-speed rail
- Maglev
- Hyperloop

The level of development and the maturity of the UHSGT technologies are substantially different (**Table 3-1**). Furthermore, there is no operational experience for the envisioned design speeds of high-speed rail (HSR), at greater than 250 mph (402 km/h), although the French *Train à Grande Vitesse* (TGV) train was tested at speeds in excess of 350 mph (574.8 km/h) on April 3, 2007, on the new *Ligne à Grand Vitesse* (LGV) Est in France.

Table 3-1. Types of Ultra High-Speed Ground Transportation Systems

Technology Option	Current Maximum Speed	Maximum Design Speed	Maximum Seating Capacity	Minimum Horizontal Curve	Maximum Gradient
High-speed Rail	220 mph (354 km/h)	250 mph (402 km/h)	1,500	4.7 miles (7.6 km)	4%
Maglev	270 mph (435 km/h)	375 mph (604 km/h)	824	5.7 miles (9.1 km)	10%
Hyperloop	200 mph* (322 km/h)	760 mph (1,223 km/h)	28 per capsule	3.0 miles (4.8 km)	Not applicable

\*Test track speed, which was limited by length of test track. Source: CH2M, 2017, *Ultra-High Speed Ground Transportation Study: Technology Options Technical Memorandum*.

## 3.1 High-Speed Rail (Steel Wheel)

Railways started regular operation almost 200 years ago. Through a steady improvement in technology, railways could operate regularly at maximum speeds of 100 mph (161 km/h) by the early 20th century, with a current maximum HSR steel wheel operational speed of 218 mph (350 km/h).

HSR is a major technological advancement, which is based on the same vehicle guiding principle as the early railways, namely steel wheel contact with guidance flanges on steel rail. High-speed rail technologies improve the competitiveness of rail against other modes of transport, help eliminate capacity bottlenecks, require less energy than cars and planes, produce a lower amount of emissions, and are safer.<sup>19</sup>

By 2030-2035, the route mileage of the world HSR network could reach more than 55,000 miles (88,514 km). See **Table 3-2** for more information on the world's high-speed rail network.<sup>20</sup>

<sup>19</sup> CH2M, 2017, *Ultra-High Speed Ground Transportation Study: Technology Options Technical Memorandum*.

<sup>20</sup> CH2M, 2017, *Ultra-High Speed Ground Transportation Study: Technology Option Technical Memorandum*.

**Table 3-2. Length of the World's High-Speed Rail Network by 2035**

Lines in Operation	14 countries	25,310 miles (40,732 km)
Lines Under Construction	16 countries	8,859 miles (14,257 km)
Lines Planned	36 countries	22,126 miles (35,608 km)
<b>Total</b>	<b>43 countries</b>	<b>56,294 miles</b> <b>(90,597 km)</b>

Source: CH2M, 2017, *Ultra-High Speed Ground Transportation Study: Technology Options Technical Memorandum*.

### 3.1.1 Future Development of High-Speed Rail

Current railway research and development programs are aiming at higher operational speeds combined with lower aerodynamic resistance of the trains and new energy transmission systems. Researchers are using a holistic and interdisciplinary approach to tackle the key questions of how the trains of the future can be faster, safer, more comfortable, and more environmentally friendly.

The main objective is to raise the maximum running speed by 25 percent without breaching existing safety standards while simultaneously halving energy consumption. In addition, noise emissions will be reduced and travelers' comfort enhanced with regard to cabin pressure variations, climate control, vibration, and acoustics. A close look at today's HSR transport, however, reveals that these attributes often compete and conflict with each other.<sup>21</sup>

## 3.2 Magnetic Levitation (Maglev)

The main feature of the maglev technology is the levitation, i.e., guidance and propulsion of vehicles by magnetic fields. There is no contact between vehicle and guideway. For high-speed transport, there are two notable types of maglev technology: electromagnetic suspension (EMS) and electrodynamic suspension (EDS).

### 3.2.1 Electromagnetic Suspension

In EMS systems like the German Transrapid, the train levitates above a steel rail while electromagnets attached to the train are oriented toward the rail from below (**Figure 3-1**). The system is typically arranged on a series of C-shaped arms, with the upper portion of the arm attached to the vehicle and the lower inside edge containing the magnets. The rail is situated inside the C, between the upper and lower edges.

Magnetic attraction varies inversely with the cube of distance, so minor changes in distance between the magnets and the rail produce greatly varying forces. These changes in force are dynamically unstable; a slight divergence from the optimum position tends to grow, requiring sophisticated feedback systems to maintain a constant distance from the track.

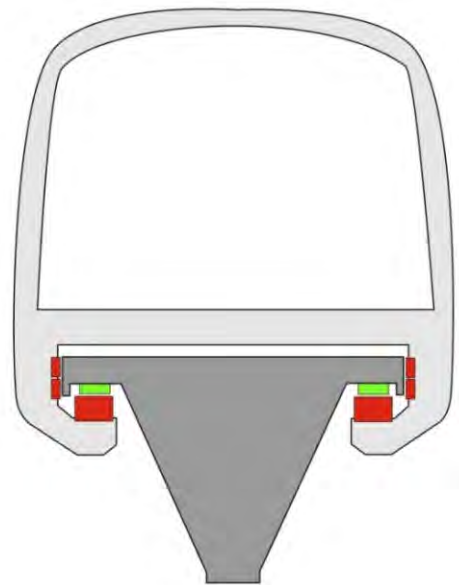

Figure 3-1. Electromagnetic Suspension

<sup>21</sup> CH2M, 2017, *Ultra-High Speed Ground Transportation Study: Technology Options Technical Memorandum*.



The major advantage to EMS maglev systems is that they work at all speeds, unlike EDS systems, which only work at a minimum speed of about 19 mph (30 km/h). This eliminates the need for a separate low-speed suspension system, and can simplify track layout. On the downside, the dynamic instability of EMS demands fine track tolerances, which can offset this advantage.<sup>22</sup>

### 3.2.2 Electrodynamic Suspension

Japan's superconducting maglev (SC maglev) EDS system, currently under construction, is powered by the magnetic fields induced on either side of the vehicle through the passage of the vehicle's superconducting magnets (**Figure 3-2**).

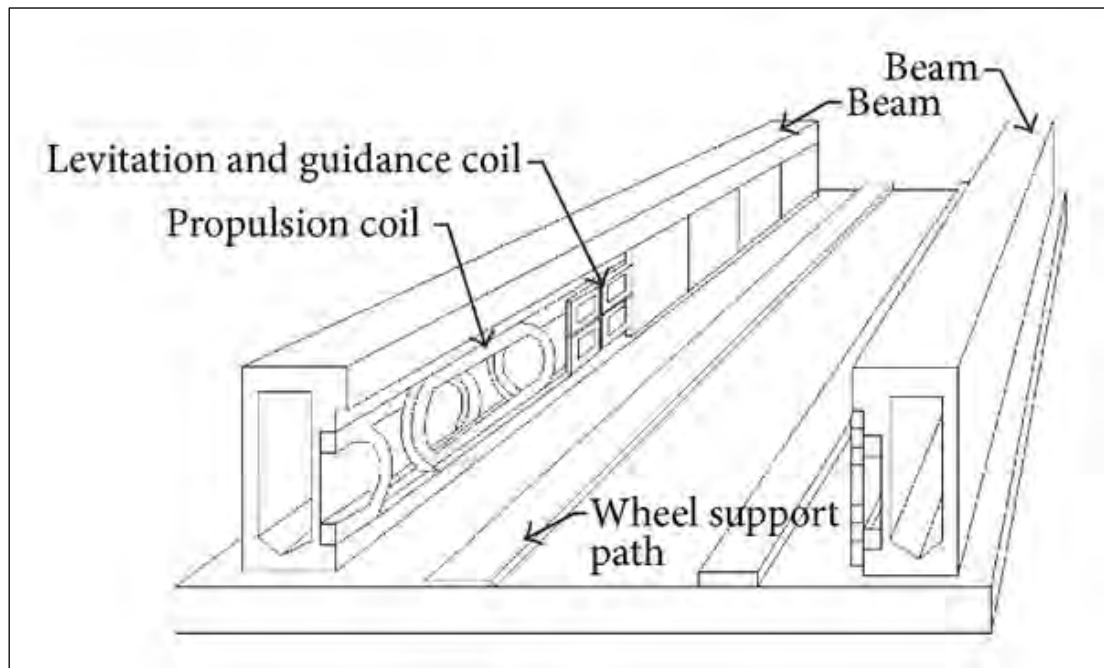

Figure 3-2. Schematic Diagram of EDS Maglev System

Source: CH2M, 2017, Ultra-High Speed Ground Transportation Study: Technology Options Technical Memorandum .

In EDS, both the guideway and the train exert a magnetic field, and the train is levitated by the repulsive and attractive force between these magnetic fields. The magnetic field is produced by superconducting magnets. The repulsive and attractive force in the track is created by an induced magnetic field in wires or other conducting strips in the track. A major advantage of EDS maglev systems is that they are dynamically stable; changes in distance between the track and the magnets create strong forces to return the system to its original position. However, at slow speeds, the current induced in these coils and the resultant magnetic flux is not large enough to levitate the train. For this reason, the train must have wheels or some other form of landing gear to support the train until it reaches take-off speed. Since a train may stop at any location, due to equipment problems for instance, the entire track must be able to support both low- and high-speed operation.

To date, only one maglev system is in operation. The Shanghai Maglev Train (Transrapid) in China is the fastest commercial train currently in operation and has a top speed of 270 mph (430 km/h) See **Figure 3-3** below for an illustration of the Shanghai Maglev Train. The line was designed to connect Shanghai Pudong International Airport and the outskirts of central Pudong, Shanghai. It covers a distance of 19.0

<sup>22</sup> CH2M, 2017, Ultra-High Speed Ground Transportation Study: Technology Options Technical Memorandum.

miles (30.5 km) in 8 minutes. The Shanghai Maglev Train demonstration line, or initial operating segment, has been in commercial operation since April 2004 and now operates 115 daily trips.<sup>23</sup>



Figure 3-3. Shanghai Maglev Train

Source: CH2M, 2017, Ultra-High Speed Ground Transportation Study: Technology Options Technical Memorandum.

### 3.2.3 Future Development

The Chuo Shinkansen is a Japanese superconducting maglev line under construction between Tokyo and Nagoya and planned to be extended to Osaka (**Figure 3-4**). The line is expected to connect Tokyo and Nagoya in 40 minutes by 2027, and eventually Tokyo and Osaka in 67 minutes, running at a maximum speed of 314 mph (505 km/h). About 90 percent of the 177.5-mile (285.6-kilometer) line to Nagoya will be built underground or through tunnels.



Figure 3-4. Chuo Shinkansen Map

Source: CH2M, 2017, Ultra-High Speed Ground Transportation Study: Technology Options Technical Memorandum.

<sup>23</sup> CH2M, 2017, Ultra-High Speed Ground Transportation Study: Technology Options Technical Memorandum.

In 2016, the FRA awarded \$27.8 million to Maryland Department of Transportation to prepare preliminary engineering and an environmental impact analysis in compliance with the National Environmental Policy Act for a proposed high-speed ground transportation line between Baltimore, Maryland, and Washington, DC, with an intermediate stop at Baltimore-Washington International Thurgood Marshall Airport. Baltimore-Washington Rapid Rail, the private company proposing the system, is aiming for an optimum speed of over 300 mph (482 km/h) that would enable an approximately 15-minute travel time between Washington and Baltimore. The system would require a guideway (track) and three stations, a rolling stock storage depot, maintenance facility, power substations, ventilation plants, and an operations facility. **Table 3-3** summarizes existing and planned EMS and EDS maglev lines.

Table 3-2. Length of the Maglev Lines

<b>Lines in operation</b>	1 country	19.0 miles (30.5 km)
<b>Lines under construction</b> <b>Yamanashi Test Track</b>	1 country	177.5 miles (285.6 km) 26.6 miles (42.8 km)
<b>Lines planned</b>	1 country + various studies	95 miles (152 km)

Source: CH2M, 2017, *Ultra-High Speed Ground Transportation Study: Technology Options Technical Memorandum*.

## 3.3 Hyperloop

Hyperloop is a proposed mode of passenger and/or freight transportation using magnetic propulsion to carry vehicles through highly evacuated tubes with very high speed. The main goal of the concept is to reduce the air resistance and therefore to enable very high speeds combined with moderate energy consumption.

The Hyperloop high-speed technology has three main components: passive magnetic levitation to reduce friction of the vehicles on the system, an electric linear induction motor to propel the vehicle, and a vacuum chamber system to reduce environmental pressure and drag on the vehicles. Theoretically, the combination of these components enables this transportation system to operate at high-speeds, estimated to be over 760 mph (1,100 km/h). The system is also anticipated to function fully autonomously, both within the hyperloop system and outside the hyperloop system for first/last mile connectivity.

Beyond the core system, the operational model of the Hyperloop system is still under development. The system vehicles for passenger travel have been described as smaller group transit, with capacity estimated at 12 to 30 passengers per vehicle, traveling more point to point with limited, if any, stops between city pairs. The headway between vehicles has been described as very short, under 10 seconds in most cases. The loading/unloading and system operations for this type of operation have not been publicly detailed, but operation with such minimal headways and operations that include launching a vehicle in a depressurized system are likely to be key considerations moving forward to commercialization.

Elon Musk's version of the concept, first publicly mentioned in 2012,<sup>24</sup> incorporates reduced-pressure tubes in which pressurized capsules ride on air bearings driven by linear induction motors and air compressors.

### 3.3.1 Hyperloop Case Uses

The case use of hyperloop technologies has been identified to be similar to rail technology case uses. Both cargo and passenger transportation have been the primary case use for the technology, with the

<sup>24</sup> CH2M, 2017, *Ultra-High Speed Ground Transportation Study: Technology Options Technical Memorandum*.

cargo being containerized or palletized goods. For passengers, vehicle sizes ranging from 4 to 36 passengers have been described as potential case use.

The Hyperloop Alpha<sup>25</sup> concept was first published in August 2013, proposing and examining a route running from the Los Angeles region to the San Francisco Bay Area roughly following the Interstate 5 corridor. The paper conceived of a Hyperloop system that would propel passengers along the 350-mile (560-km) route at an average speed of around 600 mph (970 km/h), with a top speed of 760 mph (1,200 km/h), allowing for a travel time of 35 minutes, which is considerably faster than current rail or air travel times.<sup>26</sup>

### 3.3.2 Current Development and Studies

Several studies have been conducted worldwide to determine the case use and feasibility of using hyperloop technologies. Studies have included passenger-only systems, cargo-only systems, and passenger and cargo mixed systems. Of these studies, none have been publicly released that include design documents that definitively detail geometric constraints, operational model, costs, or technology requirements. The studies have been more academic to understand impacts and benefits of a high-speed, easily accessible, and autonomous transportation system.

Only two test tracks have been built to test the technology, a 1-km test track for SpaceX (operated by Elon Musk) and a 500-meter test track for Hyperloop One. While these test tracks are viable ways to test components of the technology, it is anticipated that a track of much greater length and scale would be required to gain certification and validation of the operations and feasibility of the technology. No operational demonstrations have been built to show how the system would be loaded and operated autonomously, which may be examined at a later time. The autonomous technology is still being developed for vehicles. The two short experimental sections are:

- SpaceX's test facility, Hawthorne, California. Length 0.8 mile (1.25 km), tube diameter 6 feet (1.83 meters), max speed reached 220 mph (354 km/h).<sup>27</sup>
- Hyperloop One's "DevLoop," Nevada. Length 0.31 mile (500 meters), full-scale test structure, tube diameter 11 feet (3.4 meters), max speed reached 192 mph (309 km/h).<sup>28</sup>

In 2015, Elon Musk announced a Hyperloop Competition and a group, connected through reddit, formed a team called rLoop. Today rLoop consists of over 1,200 people from more than 50 countries who have collaborated to develop to Hyperloop technology. rLoop has made great strides in development of a Hyperloop prototype to date, including the first pod to achieve static levitation in vacuum and to demonstrate pressure vessel sustaining human life in vacuum.<sup>29</sup>

A team from China Aerospace Science & Technology Industry Corp., who attended the 3rd China (International) Commercial Aerospace Forum in Central China's Wuhan, Hubei Province in August 2017, announced plans to launch a research and development project with plans to develop hyperflight transport with maximum speeds reaching 2,485 mph (4,000 km/h).<sup>30</sup> Hyperloop technology, at the time of this report, is still developing. The technology should be monitored to determine feasibility for an UHSGT system in the future.

<sup>25</sup> CH2M, 2017, *Ultra-High Speed Ground Transportation Study: Technology Options Technical Memorandum*.

<sup>26</sup> CH2M, 2017, *Ultra-High Speed Ground Transportation Study: Technology Options Technical Memorandum*.

<sup>27</sup> CH2M, 2017, *Ultra-High Speed Ground Transportation Study: Technology Options Technical Memorandum*.

<sup>28</sup> CH2M, 2017, *Ultra-High Speed Ground Transportation Study: Technology Options Technical Memorandum*.

<sup>29</sup> rLoop, 2017. [www.rloop.org](http://www.rloop.org). Accessed on December 11, 2017.

<sup>30</sup> CH2M, 2017, *Ultra-High Speed Ground Transportation Study: Technology Options Technical Memorandum*.

### 3.3.3 Hyperloop Outlook and Recommendations

While hyperloop technology promises to be a highly innovative transportation mode that could enable true high-speed ground transportation, the development of the technology is still in early stages. The technology is moving quickly, but will require coordination and acceptance from regulatory agencies on design, operations, security, and safety. It is not anticipated that hyperloop technologies will be ready for commercial viability for at least the next decade, and viability is highly dependent on regulatory acceptance of the technology. Agencies and owners will need to study the technology and assist in developing standards and regulations that can drive the development of the technology based on what is actually needed for an advanced transportation system. Because there are currently no commercially viable operations, which are required in order to develop order-of-magnitude operation and maintenance (O&M) and capital costs for the CONNECT model, Hyperloop is described in this technology section, but was not utilized in the model runs described in Section 5.



# Study Corridor Concepts

The corridor concepts described in this report were developed through a review of several high-speed rail studies and websites containing information on development of high-speed rail in the Pacific Northwest.<sup>31</sup> In addition, screening criteria were developed to inform the development of corridor concepts and to assess them. This study considered five corridor concepts with various numbers and locations of stations (stops) between Portland, Oregon, and Vancouver, British Columbia. Additional connections east to Spokane and south to Sacramento were considered as potential connecting corridors for travel market assessment.

## 4.1 Corridor Concept Development

The high-level screening criteria presented in this report defined the key UHSGT physical, operational, and service characteristics for ridership forecasting and economic (benefits and costs) effects analyses, including inputs to and outputs from the FRA's CONNECT model. The study team applied corridor screening criteria, along with the analysis outputs, to help narrow potential conceptual corridors to a representative set of UHSGT conceptual corridors as the basis for this high-level study.

A review of previous high-speed rail feasibility studies completed in Washington, Colorado, and Texas and Oklahoma<sup>32</sup> informed the development of the screening criteria. The project team modified criteria to fit the anticipated needs and parameters of this high-level study. The primary assumptions that guided development of the screening criteria and corridor concepts are that the UHSGT system serving the Vancouver to Portland corridor would have an average operating speed of 250 mph (402 km/h) and (based on this operating speed) that the service would operate on a guideway within separate and dedicated right-of-way that would only stop at designated stations.

To address these key needs, the project team identified seven draft actionable public benefits objectives based on previous studies<sup>33</sup>. These guiding objectives were integrated into the screening and corridor concept development process primarily in a qualitative manner, and they include:

- Enhance intercity mobility by providing ultra high-speed transportation service as a mobility option that is competitive with automobile, bus, and air travel.
- Reduce congestion on freeways and surface streets by creating high-speed options for travelers, and enhance local commuter transit.

---

<sup>31</sup> The following sources were reviewed:

Cascadia High Speed Rail, June 20, 2017, <http://www.cascadiahighspeedrail.com/>

Colorado Department of Transportation, 2014, *Interregional Connectivity Study: Final Report*.

Fast Track Washington, June 27, 2017, <https://fasttrackwa.org/resources/>.

Seattle Transit Blog, June 24, 2017, <https://www.seattletransitblog.com/2017/02/17/the-technical-challenges-of-seattle-vancouver-high-speed-rail-part-1/>.

Texas Department of Transportation, 2014, *Final Route Alternatives Analysis Technical Memorandum: Texas-Oklahoma Passenger Rail Study*.  
WSDOT, 1992, *High Speed Ground Transportation Study*.

<sup>32</sup> CH2M, 2017, *Ultra High-Speed Ground Transportation: Corridor Concepts*.

<sup>33</sup> CH2M, 2017, *Ultra High-Speed Ground Transportation: Corridor Screening Criteria*.

- Provide infrastructure for a high-quality intercity transportation service that will reduce travel time, increase schedule reliability, and increase traveler comfort.
- Provide a world class transportation option for intercity travel that is much safer than driving, which could result in a mode shift from single-occupancy vehicles and contribute to congestion relief.
- Encourage more energy-efficient and environmentally sustainable modes of intercity travel than available through current and planned highway, air, and rail modes.
- Provide an economically equitable and affordable intercity travel alternative to automobile, bus, and air service, especially for travelers that have limited access to other travel modes such as aging populations and people with disabilities.
- Enhance access and intermodal connectivity between other intercity rail services, regional transit services, and major regional airports that are situated within or linked to the Vancouver to Portland corridor.
- Enhance interregional access to employment, entertainment, recreation, health, and shopping opportunities for existing and future residents.
- Provide a cost-efficient investment where the projected UHSGT service revenue meets or exceeds operations and maintenance costs, based on service level.

The criteria in **Table 4-1** consist of both qualitative and quantitative criteria and are intended to be used to assess the public benefits, engineering feasibility, environmental considerations and constraints, and the short-term and long-term operational and infrastructure costs associated with the initial corridor concepts. Each corridor concept will be assessed and compared according to a “balance sheet” method. This method includes three ratings (low, moderate, high) to describe the relative order of magnitude of the impacts for each of the criteria along a concept corridor. This method will highlight key issues of concern and differentiate the concept corridors.

Table 4-1. UHSGT Corridor Screening Criteria

Criterion	Measure	Data Source
<b>Public Benefits</b>		
Ability to Meet Public Benefits Objectives	Qualitative assessment	Narrative description
Access to Stations	Total population of cities served by stations	U.S. Census/CONNECT model
Ridership	Annual trips	CONNECT model
Length of Route	Miles	Corridor route GIS files
<b>Engineering Feasibility</b>		
Minimize Right-of-Way/Real Estate Impacts	Acres of urban/rural right-of-way within the study area	Study route right-of-way
Runs Supportive of 250 Mph Operating Speeds in Corridor	Miles and % of (horizontal and vertical) alignment that meet UHSGT engineering design geometry parameters	Study route/GIS
Probable Tunnel Construction	Narrative description	Study route
Probable Bridge Construction		
Probable Aerial Construction		



Criterion	Measure	Data Source
Geographic Features (e.g., waterways, mountains)		
Number of Existing Structures Affected (e.g., rail, highway, transit)		
<b>Environmental Considerations and Constraints<sup>34</sup></b>		
Areas of Concern (e.g., wetlands, parks, wildlife refuges, river and stream crossings, farmland, and public schools)	Narrative description	Study route
<b>Operational and Infrastructure Considerations</b>		
Revenue/Operating Cost	Revenue/operating cost (%)	CONNECT model
Capital Cost per Passenger Mile	Capital cost per passenger mile (US\$)	
Reduce Travel Times	Time reduction vs. automobile	
Enhance Mode Share on Rail	Rail mode share (%)	

Source: CH2M, 2017, *Ultra High-Speed Ground Transportation: Corridor Screening Criteria*.

## 4.2 Concept Corridors

In addition to the screening criteria, the following considerations and constraints informed the development of the five primary corridor concept alignments:

- Average operating speed of at least 250 mph (402 km/h)
- Separate trackway or guideway with dedicated right-of-way
- Turn radii of at least 45,000 feet (13,716 meters)
- Population of cities near proposed station
- Opportunity for multimodal connects at stations

Each corridor concept will require an alignment that can support an average operating speed of 250 mph (402 km/h) or greater. To maintain this speed, a separate trackway with a dedicated right-of-way will be necessary for steel-wheel-to-steel-rail or SC maglev systems. In addition, each corridor concept alignment has turning radii that are at least 45,000 feet (13,716 meters) to maintain the 250-mph (402-km/h) operating speed. Other important factors considered include the populations of cities near a proposed station and opportunities for multimodal connections. These factors would affect potential ridership of a high-speed train and the access and mobility for the regional transportation system.

The length of this primary corridor from Portland to Vancouver is approximately 310 miles (499 km) and is within the America 2050 desirable range of 150 to 500 miles (241 to 805 km). The screening criteria listed above in Table 4-1 can be used to comparatively assess ridership potential including corridor population, corridor employment, and current travel, and identify counties with major cities. The physical criteria of existing facilities and constructability considerations were subjectively reviewed at a high level to distinguish between corridors that would each need to traverse the mountainous areas west of the Columbia River in southwestern Washington and the requirement to cross the Columbia River at Portland. The environmental feasibility criterion was also subjectively reviewed for the western

<sup>34</sup> Due to the high-level nature of this study, evaluation of environmental considerations and constraints is limited to existing GIS data. Conceptual alignments would need to undergo a more detailed analysis to advance into project development.

half of the corridor that has a relatively high number of ecologically sensitive areas and/or recreational activity areas.

Five corridor concepts were developed that decrease in the number of stops included in the alignment and that have different termini (urban vs. suburban), which impacts operating and capital cost estimates inputs tested in the CONNECT model. Fewer stations would result in shorter travel times between the largest cities. **Table 4-2** outlines the nearest potential station locations for each of the five corridor concepts. The potential station locations listed are for study purposes only for comparative use in this study.

The WSDOT study team’s intent with using CONNECT to test the five primary conceptual corridors was to learn how each of the corridors performs based upon differences primarily in terms of number and locations of stations. For each of the five primary corridors, the team also wanted to be able to determine whether the higher speed of maglev would generate any significant difference in ridership over steel wheel technology at a lower average operating speed. For corridors 1 and 1A, the team was interested in determining the effects of providing stops at “minor” stations in the Bellingham and Olympia-Tumwater CBSAs in addition to “major” stations in Vancouver, Seattle-Tacoma, and Portland. For concept corridors 1A and 2, the team wanted to learn what ridership variations result from an airport stop versus a downtown core station in Vancouver (1A) and Portland (2) with consideration of capital costs differences associated with an outlying airport station. Concept corridors 3 and 4 would be similar in terms of limiting service to the three largest population centers along the corridor, and for concept corridor 4, the team wanted to learn how much reducing costs associated with using minor stations on the periphery of the denser urban core could affect cost recovery results.

**Table 4-2. Key Assumptions for Conceptual Corridors (For study purposes only)**

Corridor	Nearest Station Locations	Defining Characteristics
1	Pacific Central Station – Vancouver, BC Fairhaven Station – Bellingham, WA Everett Station (new station near Delta Yard) – Everett, WA Stadium Station – Seattle, WA Tacoma Dome Station – Tacoma, WA Centennial Station – Lacey, WA Rose Quarter Station (TriMet Max station) – Portland, OR	<ul style="list-style-type: none"> <li>Stations in urban core</li> <li>Does not include an airport station location</li> <li>295 miles (475 km)</li> </ul>
1A	Vancouver International Airport – Vancouver, BC Fairhaven Station – Bellingham, WA Everett Station – Everett, WA Stadium Station – Seattle, WA Tacoma Dome Station – Tacoma, WA Centennial Station – Lacey, WA Rose Quarter Station – Portland, OR	<ul style="list-style-type: none"> <li>Combinations of urban core and periphery stations</li> <li>Airport station in Vancouver, BC</li> <li>All seven cities identified in legislation</li> <li>283 miles (455 km)</li> </ul>
2	Pacific Central Station – Vancouver, BC Stadium Station – Seattle, WA Tacoma Dome Station – Tacoma, WA Portland International Airport, Portland, OR	<ul style="list-style-type: none"> <li>Fewer potential stations</li> <li>Major stations in 4 largest cities</li> <li>Airport station in Portland, OR</li> <li>282 miles (454 km)</li> </ul>
3	Pacific Central Station – Vancouver, BC Stadium Station – Seattle, WA Rose Quarter Station – Portland, OR	<ul style="list-style-type: none"> <li>Fewest potential stations with 3 potential station locations</li> <li>Station locations in urban core</li> <li>Does not include airport station location</li> <li>288 miles (463 km)</li> </ul>

Corridor	Nearest Station Locations	Defining Characteristics
4	King George Station – Surrey, BC Tukwila Station – Tukwila, WA Expo Center Station – Portland, OR	<ul style="list-style-type: none"> <li>• Fewest potential stations with 3 potential station locations</li> <li>• Station locations in urban periphery outside of 3 largest cities</li> <li>• Does not include airport station location</li> <li>• 270 miles (435 km)</li> </ul>

Source: CH2M, 2017, *Ultra High-Speed Ground Transportation: Corridor Concepts*.

**Figures 4-1** through **4-3** are map representations of concept corridors 1A, 2, and 4 the three concepts that the project team selected for additional rounds of testing in CONNECT. Each corridor concept and are for study purposes only. Each figure shows nearby major transportation facilities and illustrates the alignment by grade type, including at grade, below grade, elevated, and tunnel, defined as follows:

- At grade: within +/- 5 to 10 feet (1.5 to 3 meters) of ground surface
- Below grade: 10 to 20 feet (3 to 6 meters) below ground surface (includes a retaining wall, trench, and/or embankment)
- Tunnel: 20 feet (6 meters) or more below ground surface (bored or cut-and-cover construction)
- Elevated: 20 feet (6 meters) or more above ground surface (on a viaduct or bridge)

Corridor concepts 1 and 1A are nearly identical except for the station locations in Vancouver, BC. Corridor concept 1 terminates at the Pacific Central Station area whereas the northern terminus of concept 1A is located at Vancouver International Airport. Station locations were selected based on the WSDOT 1992 study, more recent concepts developed by other parties, and with consideration of potential ridership and opportunity for multimodal connections, including with freight and aviation modes. The nearest station locations in corridor Concept 1 would serve downtowns or city centers and potentially connect to local transit services. Corridor Concept 1A would diverge from the city center in Vancouver and instead provide a connection to the airport.

Corridor concepts 1A and 2 both include station locations at airports. Airport station locations could support increases in capacity for longer-haul trips for airlines by providing an alternative modal option for short-haul trips. Long-haul trips tend to be more efficient and cost-effective for airlines.

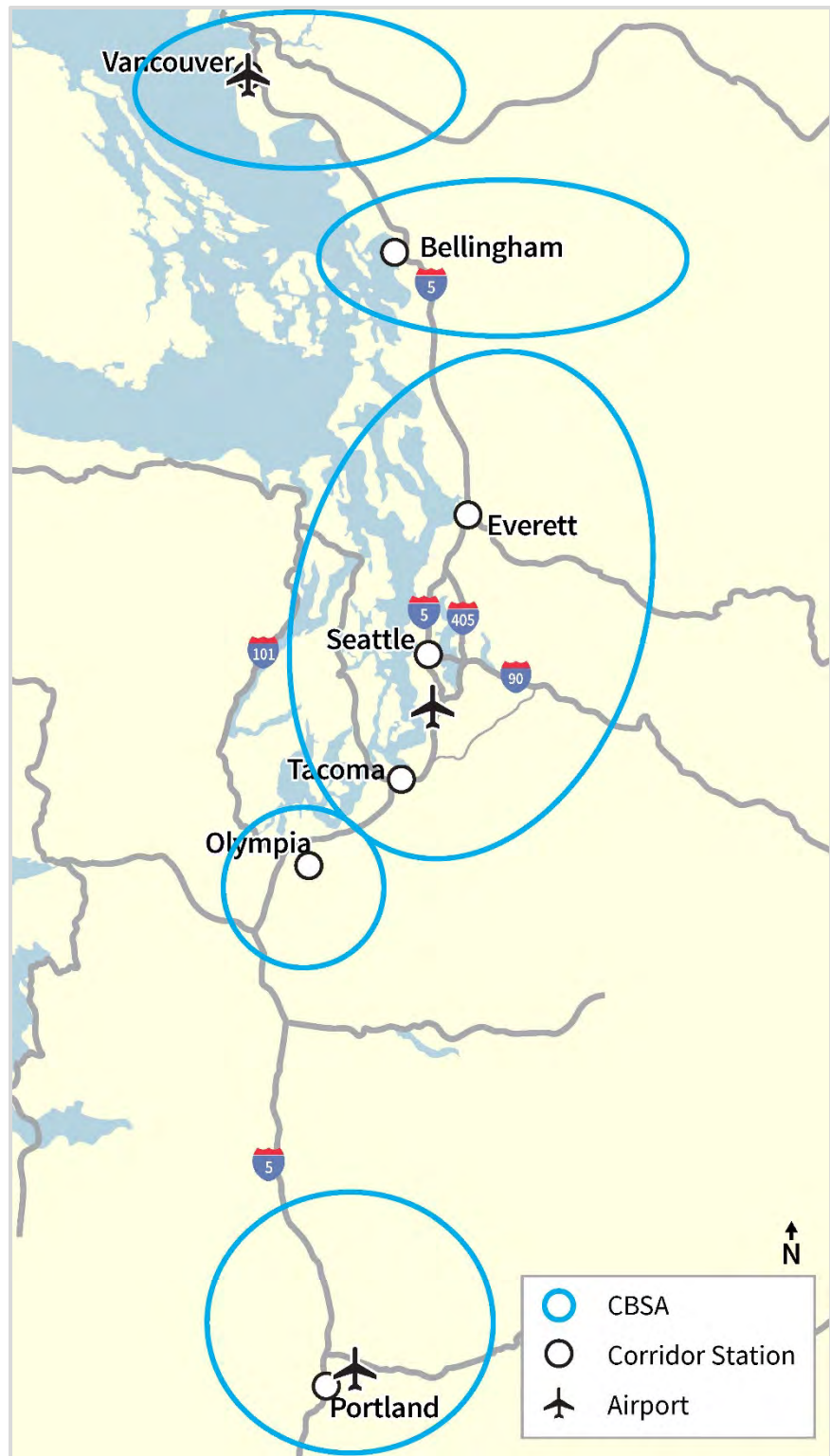

Figure 4-1. Corridor Concept 1A

Source: CH2M, 2017, Ultra High-Speed Ground Transportation: Corridor Concepts.

Corridor concepts 2 and 3 include similar station locations and numbers of stops. Concept corridor 2 includes four stops: Pacific Central Station, Stadium Station, Tacoma Dome Station, and Portland International Airport.



Figure 4-2. Corridor Concept 2

Source: CH2M, 2017, Ultra High-Speed Ground Transportation: Corridor Concepts.

Corridor concept 4 is a “low-cost” option and includes three stops at outlying stations to reduce costs for right-of-way acquisition and complex engineering approaches required for dense, urbanized areas. Stations include King George Station, Tukwila Station, and the Expo Center Station. In addition, the

southern terminus in Portland is near several special event venues, including the Oregon Convention Center, the Moda Center, and the Veterans Memorial Coliseum.

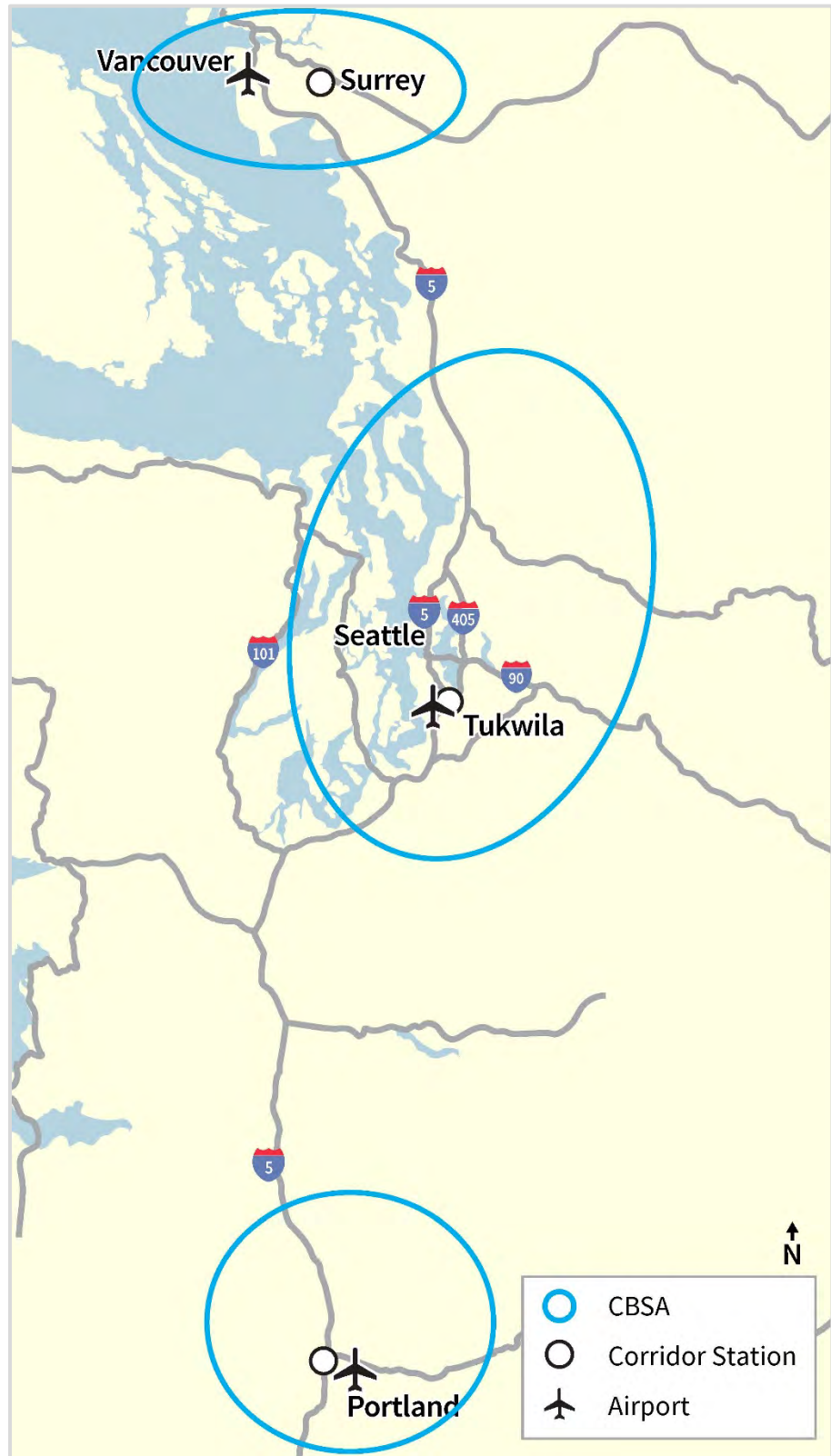

Figure 4-3. Corridor Concept 4

Source: CH2M, 2017, Ultra High-Speed Ground Transportation: Corridor Concepts.

## 4.3 Connecting Corridor Considerations

In addition to evaluating the five primary corridor concepts, the project team evaluated two connecting corridors: one east-west corridor and one north-south corridor. The East-West Corridor connects to the primary corridor at Tukwila, travels east, and terminates in Spokane. The North-South Corridor connects to the primary corridor at Portland and travels south to Sacramento, California.

### 4.3.1 East-West Corridor Description

The East-West corridor connects to the BNSF mainline south of Seattle to the Ellensburg, Yakima, Tri-Cities, and Spokane urban areas in Washington. This study corridor, illustrated in **Figure 4-4** and as defined for study purposes, would connect to the Vancouver-Seattle-Portland corridor by following a portion of the “mainline that BNSF owns and operates as freight rail. This line connects to the north-south mainline in Auburn, Washington. Heading east towards the Cascade Mountains, the line rises to 2,840 feet (866 meters) and crosses the mountains via the 1.8-mile (2.9 km) long Stampede Tunnel, then continues through the communities of Ellensburg and Yakima, and then continuing southeast through the Yakima Valley to the Tri-Cities (Kennewick, Richland, and Pasco) area where the Stampede Pass line connects with the Pasco East main line in Pasco, which continues north to Spokane on a portion of the same line used by the Amtrak Empire Builder route to Chicago.

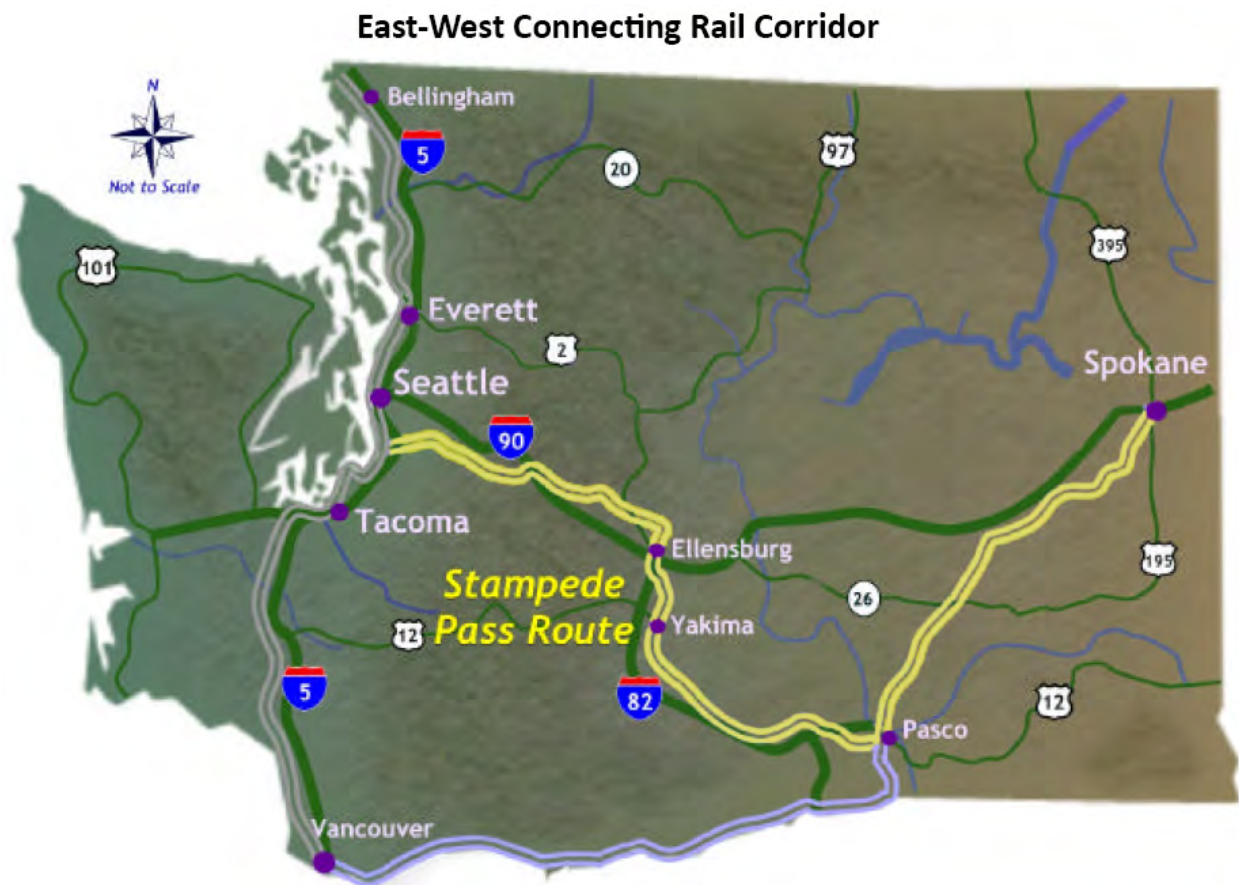

Figure 4-4. East-West Corridor  
Source: CH2M

There are four general station locations along this East-West Corridor. These stations represent possible station sites along the corridor to determine the relative network effects upon potential ridership and cost recovery of connecting a potential emerging intercity passenger rail line with a UHSGT system in

Washington. The preliminary location of these station sites is based on providing service to major metropolitan areas and maintaining minimum station spacing to facilitate optimum operating conditions. The final number and location of stations were not determined as part of this study.

The general station areas assumed for study purposes are listed below:

- South Seattle/Tukwila
- Ellensburg
- Tri-Cities area (Kennewick, Richland, Pasco)
- Spokane

### 4.3.2 North-South California Corridor Description

The project team identified seven general station locations along this conceptual North-South corridor to connect to the California HSR system in Sacramento, California. These stations represent possible station sites along the corridor to determine the relative potential for a high-speed ground transportation system connecting Oregon to central California and California's proposed HSR statewide network. The preliminary locations of these station sites are based on providing service to major metropolitan areas and maintaining minimum station spacing to facilitate optimum operating conditions. The final number and location of stations were not determined as part of this study. The general station locations assumed for study purposes are:

- Portland, Oregon
- Salem, Oregon
- Eugene, Oregon
- Medford, Oregon
- Redding, California
- Chico, California
- Sacramento, California

The North-South Portland to Sacramento corridor would likely require very high capital costs for a dedicated high-speed rail corridor and relatively low ridership and revenue network potential due to a sparsely populated area and mountainous terrain. The recently released *2018 California State Rail Plan* does not include any high-speed rail connection north of Sacramento and limits intercity rail service to the existing Amtrak *Coast Starlight* and connecting thruway bus services to Redding, California. Additional CONNECT analysis of this connecting corridor is still being performed and will be the subject of a future addendum to this study.



# Corridor Analysis

## 5.1 Evaluation Methodology

The evaluation methodology was developed to ensure an appropriate balance between market potential, train operations, and engineering costs for a high-level study. The methodology provides a structured way of examining the trade-offs of the financial and economic values of selected alternatives. The method reflects closely the procedures and evaluation criteria adopted by the FRA for high-speed rail and maglev planning as defined by two reference publications:

- *High Speed Ground Transportation for America*, FRA, 1997
- *Maglev Deployment Program*, FRA, 1999

The screening of alternatives employed an iterative process starting with a wide array of alternatives and then narrowed the alternatives to a smaller, more manageable level based on preliminary findings. The analysis utilized the CONceptual NETwork Connections Tool (CONNECT) sketch planning model developed by the FRA for high-level passenger rail network evaluation. This section will describe the CONNECT tool and its limitations and then describe the iterative screening process.

### 5.1.1 CONNECT Sketch Planning Tool

CONNECT is a sketch planning model that estimates ridership, revenue, and costs of high-speed and intercity passenger rail corridors and networks. Originally developed as part of the FRA National Planning Study, CONNECT is a CBSA-to-CBSA<sup>35</sup> based planning model. It is intended for use at the outset of the study process, before detailed alignment and operational plans are developed. CONNECT outputs are not a substitute for more detailed ridership and revenue studies required for FRA service development plans or for investment-grade analysis of feasibility.

The user can build a desired HSR network and develop associated service plans, generate operational data, and bracket the financial and operational performance for the network with CONNECT. The analytical process is driven by user inputs. These include network configuration and capital and O&M costs, as well as operational and infrastructure assumptions. Outputs include ridership, revenue, capital cost estimates, O&M estimates, and public benefit estimates for the user-defined network. CONNECT can also provide a series of charts developed from summary level data to support a conceptual analysis of network performance.

#### 5.1.1.1 Intended Use

The FRA developed CONNECT to provide an up-front analytical basis for the decisions shaping HSR network planning. CONNECT produces order-of-magnitude ridership, revenue, costs, and public benefits that enable the user to understand relative differences in service alternatives and should only be used for comparative purposes. The outputs also enable the user to assess the relative importance of network connectivity. The ultimate goal of a CONNECT analysis is help the user identify the more viable and attractive alternatives before proceeding to more detailed and corridor-specific network assessments.

---

<sup>35</sup> A Core Based Statistical Area (CBSA) is a U.S. geographic area defined by the Office of Management and Budget. A CBSA consists of one or more counties (or equivalents) anchored by an urban center of at least 10,000 people plus adjacent counties. The counties are tied socioeconomically to the urban center by commuting.

CONNECT can also supplement ongoing corridor analyses. The model can be used in regions that have corridors already undergoing detailed planning, but where potential markets outside of the study area have not been evaluated. In such a case, CONNECT can help the user sense the importance of connecting markets and the potential impact of these markets on the future network.

#### 5.1.1.2 CONNECT Limitations

As noted previously, CONNECT is not a substitute for detailed corridor and network planning and will not produce investment-grade results. The estimates of ridership, revenue, capital and O&M costs, and public benefits must be considered as order-of-magnitude estimates. Nevertheless, these estimates empower the user to conceptualize and compare the potential performance of the user's defined network.

CONNECT uses generalized calculations that generate typical rather than corridor-specific outputs. CONNECT cannot be expected to reflect with accuracy the ridership, revenue, or costs of existing corridors. But the results are indicative and can be used to compare alternatives and determine general feasibility.

Furthermore, analyzing corridor and network performance only on a CBSA-to-CBSA basis limits CONNECT's outputs. For example, multiple station stops in one CBSA will not alter the ridership results, but it will increase travel time, which impacts ridership results. In addition, CONNECT cannot account for trips less than 50 miles (80.5 km) or greater than 850 miles (1,368 km). This generally eliminated intercity trips within the CBSA. It also became a limitation when assessing the connecting corridor all the way to Sacramento which connected to the California High Speed Rail System; certain longer distance markets were precluded by the model's distance limitations so some network effect revenue and ridership was excluded.

Importantly, the capital cost calculations are derived by a simplified costing model driven by inputs provided by the user and not by actual infrastructure assessments. The cost of capital (debt service), for example, is not included in these calculations. The costing model uses unit costs derived from domestic and international averages. They can be modified by the user as has been done in this study for both the HSR and maglev inputs. The model has embedded steel wheel HSR capital costs, but has no inputs for maglev; the project team derived those capital cost inputs from similar planning work team members had performed around the world on maglev projects. Even with these user-provided inputs, these averages are meant to reflect typical rather than local conditions. To calculate O&M costs, CONNECT applies a simplified service plan consisting of daily frequencies and average speeds to drive the cost estimates and similar to the capital cost calculations, uses domestic and international averages as well as a large number of similar estimates for maglev operation.

In terms of revenue, CONNECT only looks at projected fare revenue. Ancillary revenues such as real estate development, commercial leases, value capture, tax increment financing, etc., are all location specific and are not included in this model. For that reason, this model may underestimate, given specific locations, the ultimate project's revenue potential.

CONNECT presents the ridership, revenue, cost, and public benefit outputs in ranges having low, medium, and high values. The ranges are intended to capture typical conditions for the set of inputs provided by the user.

Lastly, for the best results the user must input reasonable assumptions for the user's corridors and network. The user should consider all outputs as conceptual and preliminary to a more detailed analysis of corridor-specific conditions. Only a more finely tuned analysis can develop the ridership and cost estimates needed for specific corridor planning or investment decision-making.

## 5.1.2 Screening Process

Although each of the corridors under investigation can technically accommodate UHSGT, each corridor has alignment issues and potential impacts associated with such an investment. Moreover, the purpose of the corridor analysis process is to investigate the appropriateness and cost-effectiveness of various UHSGT technology options being studied. Consequently, an array of alignment options can be developed to solve specific transportation problems in the corridors linking Vancouver, Seattle, and Portland and beyond. These specific alignment alternatives were not analyzed in detail as doing so is beyond the scope of this study.

For this study, a high-level defined multi-step screening and evaluation process was used. The final ridership results are the product of an iterative process running the CONNECT tool with incremental changes over multiple rounds. The initial round of ridership results tested only the primary corridor from Portland to Vancouver, and included 10 scenarios, which were all run with a forecast year of 2035 and a daily frequency of 28 roundtrips, which is equivalent to half-hourly service, tapering at the start and end of the day. The 10 model runs were comprised of each of the five conceptual corridors (examining a variety of stopping patterns) for both HSR and maglev technology (**Figure 5-1**).

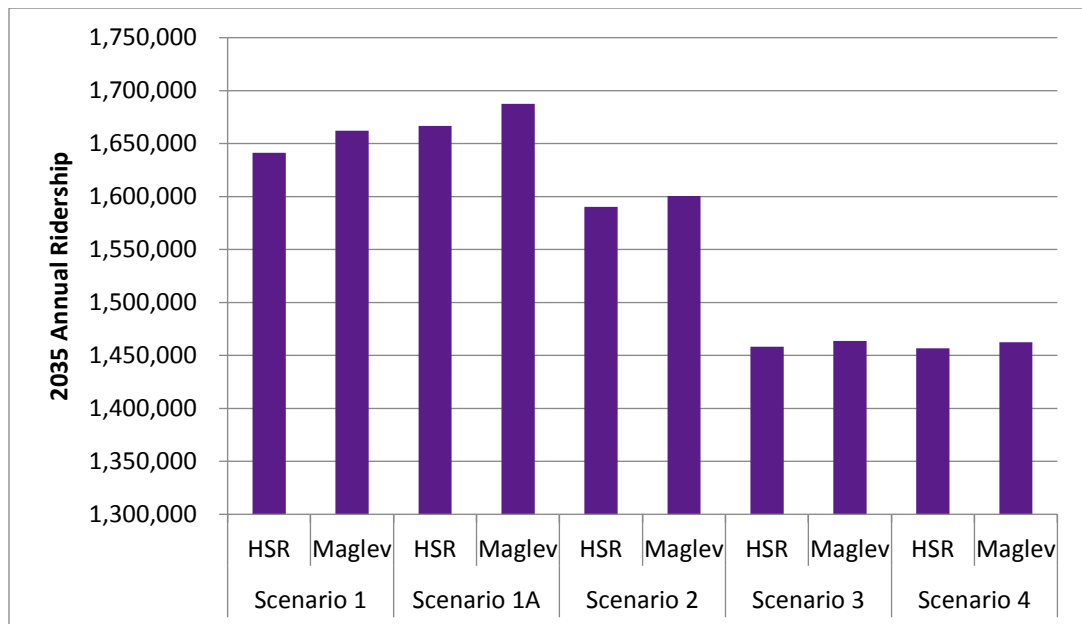

**Figure 5-1. Round 1 Ridership Comparison**  
 Source: AECOM derived from CONNECT results

To account for the differences in technology and not exclude any specific technology, the team adjusted the default values of the operating and cost assumptions in the CONNECT tool, as described above, which includes operating characteristics such as speed and operating and construction costs. After reviewing the results of the initial round, which included a sensitivity analysis varying the daily frequency, the team made the following adjustments for the second round of CONNECT tool runs:

- Adjusted some of the input cost assumptions for the HSR and maglev technologies.
- Reduced the daily frequency to eight daily round trips. The first CONNECT runs showed that that the inflection point is approximately at eight trains per day on the sensitivity curve of the total recovery ratio<sup>36</sup> versus the daily frequency.

<sup>36</sup> In the CONNECT tool this is defined as the annual ticket revenue divided by the total costs, annualized.

- Added in the forecast year of 2055 to examine longer range future ridership potential.

The concept corridors were reduced to three (1A, 2, and 4), as the differences between the corridors were minor and including all five primary corridors was redundant for analysis purposes. These three represent the range of ridership, cost, and geographic coverage. For concept corridor 1A, the project team wanted to find out the effects of providing stops at “minor” stations in the Bellingham and Olympia-Tumwater CBSAs in addition to “major” stations in Vancouver, Seattle-Tacoma, and Portland. For concept corridors 1A and 2, the project team wanted to learn what ridership variations result from an airport stop as compared to a downtown core station in Vancouver (1A) and Portland (2) with consideration of capital costs differences associated with an outlying airport station. Concept corridor 4 limits service to the three largest population centers along the corridor and the project team wanted to learn how much reducing costs associated with using minor stations on the periphery of the denser urban core could affect ridership and revenue results. **Figure 5-1**, compares the ridership results across the corridors.

For the last round of CONNECT, two additional changes were made:

- Increased daily frequencies up to 12, as the frequency sensitivity curve was adjusted due to the changes in the cost inputs, as can be seen in **Figure 5-2**.
- Added in the East-West corridor connecting Seattle to Spokane.
- While the connecting corridor to Sacramento was run using CONNECT, the results are still be analyzed as of the publication of this study. Model limitations and the network impact of connecting to the extensive proposed California High-Speed Rail system require more detailed evaluation and will be the subject of a future addendum to this report.

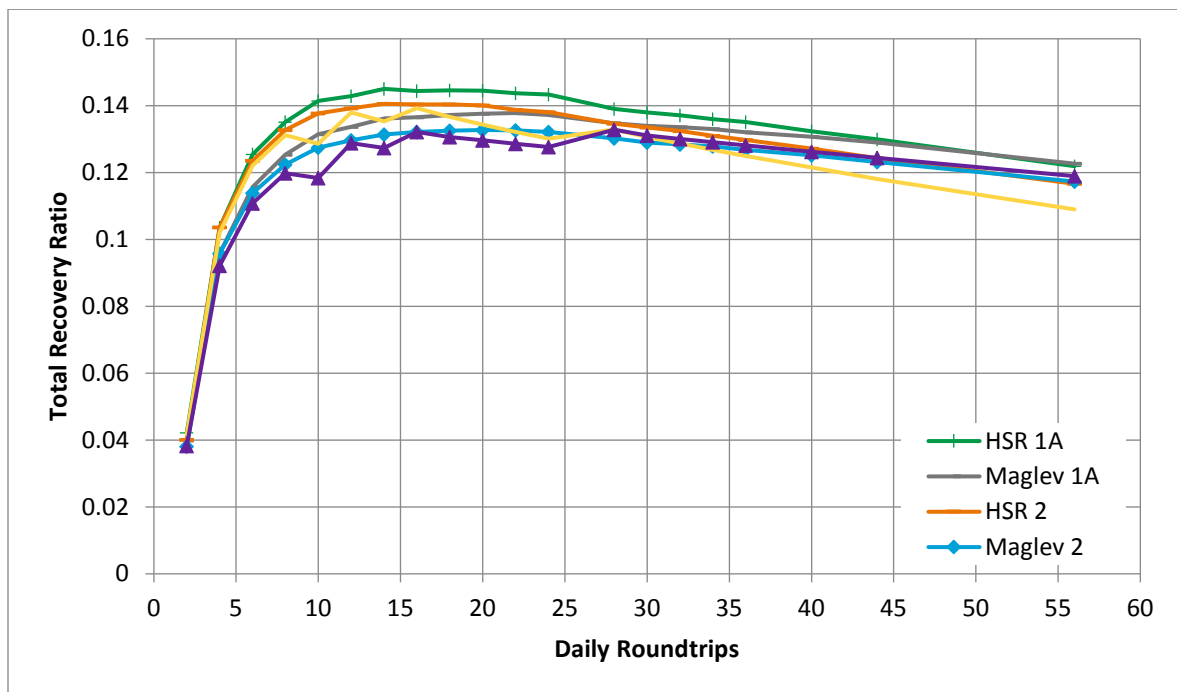

Figure 55-2. Round 2 Total Recovery Ratio Frequency Sensitivity  
Source: AECOM derived from CONNECT results

## 5.2 Feasibility for Future Federal Funding Availability

Determining project feasibility is the initial design stage of any project. This phase of study brings together the elements of knowledge that indicate if a project is possible or not. While not a detailed

feasibility study required to meet federal funding standards, the UHSGT Study did focus on determining whether options exist that ultimately may be able to satisfy criteria for technical and commercial the potential for ultra HSR. Technical viability is addressed by evaluating engineering and constructability issues and whether the vehicle technology is commercially available and revenue service ready. This study found no “fatal flaws” for the two technologies for which sufficient commercial cost data is available. For the third technology, Hyperloop, proven cost data is not yet available but there is nothing in the corridor concepts in Section 4 utilized as inputs that would preclude future comparative analysis of this technology. The critical elements of determining cost recovery include demand and ridership estimates and estimates of probable costs associated with alternatives that are technically feasible. This section discusses cost recovery feasibility as previously defined by the FRA.<sup>37</sup>

The FRA criteria for determining cost recovery include the possibility of public/private partnership for capital investments by determining the proportion of each corridor’s initial investment that might be funded or financed based on future operating surpluses. At a coarse level, CONNECT allows the user to compare alternatives and generally determine whether these Federal criteria have a possibility of being met. This is measured as:

- Low operating cost recovery ratio (operating costs/revenue)
- Positive fare recovery ratio (operating revenue/operating costs)
- Positive benefit/cost ratio (direct + indirect benefits/total costs)

Other criteria used by FRA to determine feasibility include:

- Whether the proposed corridors include rail lines where passenger rail speeds of 90 mph (145 km/h) or more are occurring or can reasonably be expected to occur in the future. In this study, the study team are examining average speeds of 250 mph (402 km/h) or higher.
- Projected ridership associated with the proposed corridors sufficient to generate revenue that exceeds operating costs.
- Percentage of the corridors over which trains will be able to operate at maximum speed, considering such factors as topography and other traffic on the line, if tracks are shared with other train operating companies or services.
- Projected indirect benefits to non-riders, such as congestion relief on other modes of transportation providing service in the corridors.
- Amount of federal, state, and local financial support that can reasonably be anticipated for the improvement of the line and related facilities.
- Cooperation of the owners of the rights-of-way that can be reasonably expected.

This study did not examine detailed financial feasibility, which analyzes cash flows in greater detail. This more detailed financial analysis and feasibility determination is deferred to project-level study once a preferred option has been identified and environmentally cleared.

## 5.2.1 Operating Recovery Ratio and Total Recovery Ratio

### 5.2.1.1 Operating Recovery Ratio

The operating recovery ratio shows the degree to which passenger fare revenue covers operating costs. CONNECT does not account for any ancillary revenue (e.g., generated from real estate development or commercial activity). In the CONNECT tool the operating recovery ratio is the annual ticket revenue divided by the O&M costs for the primary corridor and full network. Values greater than 1.0 represent

---

<sup>37</sup> *High Speed Ground Transportation for America*, FRA, 1997, and *Maglev Deployment Program*, FRA, 1999.

an operating profit. After several iterations of analysis, the third and final round of CONNECT tool runs indicated the operating recovery ratios shown in **Tables 5-1** and **5-2** for study years 2035 and 2055. The results are shown for both the standalone primary corridor (Portland to Vancouver) and the total network results (Portland to Vancouver plus Seattle to Spokane).

**Table 5-1. Operating Recovery Ratio for 2035**

	Concept Corridor 1A Seven Stations		Concept Corridor 2 Four Stations		Concept Corridor 4 Three Stations	
	HSR	Maglev	HSR	Maglev	HSR	Maglev
<b>Standalone Primary Corridor (Portland to Vancouver)</b>						
O&M Cost Recovery Ratio	0.62 - 0.72	0.70 - 0.97	0.63 - 0.74	0.71 - 0.99	0.69 - 0.83	0.79 - 1.20
Annual OpEx per Passenger Mile	\$0.78 - 0.76	\$0.58 - 0.67	\$0.75 - 0.73	\$0.56 - 0.65	\$0.66 - 0.65	\$0.45 - 0.57
Revenue per Passenger Mile	\$0.51 - 0.51	\$0.51 - 0.51	\$0.50 - 0.50	\$0.50 - 0.50	\$0.50 - 0.50	\$0.50 - 0.50
<b>Full Network (Primary + Connecting East-West Corridor)</b>						
O&M Cost Recovery Ratio	0.50 - 0.62	0.58 - 0.83	0.51 - 0.64	0.59 - 0.85	0.54 - 0.69	0.63 - 0.97
Annual OpEx per Passenger Mile	\$0.82 - 0.75	\$0.61 - 0.66	\$0.78 - 0.73	\$0.58 - 0.64	\$0.72 - 0.68	\$0.51 - 0.59
Revenue per Passenger Mile	\$0.45 - 0.43	\$0.45 - 0.43	\$0.44 - 0.42	\$0.44 - 0.42	\$0.44 - 0.42	\$0.44 - 0.42

Source: AECOM derived from CONNECT results

**Table 5-2. Operating Recovery Ratio for 2055**

	Concept Corridor 1A Seven Stations		Concept Corridor 2 Four Stations		Concept Corridor 4 Three Stations	
	HSR	Maglev	HSR	Maglev	HSR	Maglev
<b>Standalone Primary Corridor (Portland to Vancouver)</b>						
O&M Cost Recovery Ratio	0.98 - 1.15	1.11 - 1.54	0.98 - 1.15	1.1 - 1.55	1.09 - 1.3	1.25 - 1.9
Annual OpEx per Passenger Mile	\$0.50 - 0.48	\$0.37 - 0.42	\$0.49 - 0.48	\$0.36 - 0.42	\$0.42 - 0.42	\$0.29 - 0.36
Revenue per Passenger Mile	\$0.51 - 0.51	\$0.51 - 0.51	\$0.51 - 0.51	\$0.51 - 0.51	\$0.50 - 0.50	\$0.50 - 0.50
<b>Total Network (Primary + Connecting East-West Corridor)</b>						
O&M Cost Recovery Ratio	0.79 - 0.98	0.92 - 1.32	0.79 - 0.99	0.92 - 1.32	0.86 - 1.08	1.01 - 1.54
Annual OpEx per Passenger Mile	\$0.51 - 0.48	\$0.38 - 0.41	\$0.50 - 0.47	\$0.37 - 0.41	\$0.45 - 0.43	\$0.32 - 0.37
Revenue per Passenger Mile	\$0.45 - 0.43	\$0.45 - 0.43	\$0.44 - 0.42	\$0.44 - 0.42	\$0.43 - 0.42	\$0.44 - 0.42

Source: AECOM derived from CONNECT results

### 5.2.1.2 Total Recovery Ratio

In the CONNECT tool, total recovery ratio is the annual ticket revenue divided by the total annualized capital and operating costs. Values greater than 1.0 represent an operating profit. After several iterations of analysis, the third and final round of CONNECT tool runs indicated the total recovery ratios shown in **Tables 5-3** and **5-4** for study years 2035 and 2055.

Table 55-3. Total Recovery Ratio for 2035

	Concept Corridor 1A Seven Stations		Concept Corridor 2 Four Stations		Concept Corridor 4 Three Stations	
	HSR	Maglev	HSR	Maglev	HSR	Maglev
<b>Standalone Primary Corridor (Portland to Vancouver)</b>						
Total Cost Recovery Ratio	0.09 - 0.14	0.09 - 0.13	0.08 - 0.14	0.09 - 0.13	0.08 - 0.14	0.08 - 0.13
Annual CapEx per Passenger Mile	\$3.14 - 4.62	\$3.59 - 4.53	\$3.21 - 4.7	\$3.69 - 4.77	\$3.29 - 4.92	\$3.85 - 4.95
Revenue per Passenger Mile	\$0.51 - 0.51	\$0.51 - 0.51	\$0.50 - 0.50	\$0.50 - 0.50	\$0.50 - 0.50	\$0.50 - 0.50
<b>Full Network (Primary + Secondary East-West Corridor)</b>						
Total Cost Recovery Ratio	0.09 - 0.14	0.09 - 0.13	0.08 - 0.14	0.09 - 0.13	0.08 - 0.14	0.08 - 0.13
Annual CapEx per Passenger Mile	\$2.74 - 3.64	\$3.14 - 3.61	\$2.77 - 3.66	\$3.18 - 3.75	\$2.85 - 3.86	\$3.34 - 3.92
Revenue per Passenger Mile	\$0.45 - 0.43	\$0.45 - 0.43	\$0.44 - 0.42	\$0.44 - 0.42	\$0.44 - 0.42	\$0.44 - 0.42

Source: AECOM derived from CONNECT results

Table 5-4. Total Recovery Ratio for 2055

	Concept Corridor 1A Seven Stations		Concept Corridor 2 Four Stations		Concept Corridor 4 Three Stations	
	HSR	Maglev	HSR	Maglev	HSR	Maglev
<b>Standalone Primary Corridor (Portland to Vancouver)</b>						
Total Cost Recovery Ratio	0.14 - 0.23	0.14 - 0.21	0.13 - 0.22	0.13 - 0.2	0.13 - 0.22	0.13 - 0.2
Annual CapEx per Passenger Mile	\$2.00 - 2.93	\$2.27 - 2.86	\$2.10 - 3.05	\$2.39 - 3.08	\$2.11 - 3.14	\$2.44 - 3.14
Revenue per Passenger Mile	\$0.51 - 0.51	\$0.51 - 0.51	\$0.51 - 0.51	\$0.51 - 0.51	\$0.50 - 0.50	\$0.50 - 0.50
<b>Total Network (Primary + Secondary East-West Corridor)</b>						
Total Cost Recovery Ratio	0.14 - 0.23	0.14 - 0.22	0.13 - 0.22	0.13 - 0.21	0.13 - 0.22	0.13 - 0.2
Annual CapEx per Passenger Mile	\$1.72 - 2.3	\$1.96 - 2.28	\$1.78 - 2.37	\$2.03 - 2.42	\$1.79 - 2.45	\$2.09 - 2.48
Revenue per Passenger Mile	\$0.45 - 0.43	\$0.45 - 0.43	\$0.44 - 0.42	\$0.44 - 0.42	\$0.43 - 0.42	\$0.44 - 0.42

Source: AECOM derived from CONNECT results

The CONNECT results indicate that maglev has a higher probability of covering its operating costs in the 2035-time frame than HSR, but at a slightly higher capital cost, all other things being equal. Determining the preferred technology option and alignment and service options will require more detailed study and analysis. However, this analysis indicates that HSR and maglev could each cover their operating costs by 2055, but they would only recover a small portion of the capital costs, similar to other HSR projects internationally.

## 5.2.2 Benefit/Cost Analysis

The Benefit/Cost Analysis (BCA) module outputs a time stream of project benefits and costs from the start of construction to the horizon year based on user-defined inputs and on estimates of travel demand and costs. The BCA module in the CONNECT tool automatically performs runs and calculations for all relevant study years. The CONNECT tool simplifies benefits into consumer surplus, safety, and environmental benefits, and costs into capital and O&M costs. Consumer surplus is defined as the difference between the total amount that passengers are willing and able to pay for the service offering

indicated by the demand curve and the total amount that they actually do pay defined by the ticket price. It measures the welfare benefit buyers get from participating in a market. The consumer surplus benefits incorporate travel time and volume changes by mode and trip purpose between the baseline and the project alternative for each CBSA pair. It also accounts for diversions from auto, air, and bus to rail, as well as induced rail demand. The benefit/cost analysis module of CONNECT is still in development by FRA. The BCA will be included in the separate report of Wider Economic Benefits, which will be available in January 2018.

### 5.2.3 Other Indicators of Feasibility

The analysis clearly shows that UHSGT technologies exist that have a high likelihood of being commercially available and are revenue service proven. The corridors examined present engineering challenges that are not insurmountable. Alignments can be planned, designed, and constructed in a way that does not preclude emerging UHSGT technologies with operating speeds that can exceed 250 mph (402 km/h) on a high percentage of the planned alignment outside of urban areas. Determinations on alignments within cities and the approaches to major city stations where the UHSGT systems connect with conventional speed trains have not been determined.

## 5.3 Demand and Ridership

This section describes the demand and ridership results from the final round of the CONNECT runs, which include both 2035 and 2055 estimates of ridership for conceptual corridors 1A, 2, and 4 for both HSR and maglev technologies. The results presented in **Table 5-5** for 2035 and **Table 5-6** for 2055 are shown for both the standalone primary corridor (Portland to Vancouver) as well as total network results (Portland to Vancouver plus Seattle to Spokane). The max segment load indicates how full the train is at the maximum point in the system. This section discusses elements of the ridership forecasts and compares across dimensions (corridor, technology, and forecast year).

Table 5-5. 2035 CONNECT Ridership Results

	Concept Corridor 1A Seven Stations		Concept Corridor 2 Four Stations		Concept Corridor 4 Three Stations	
	HSR	Maglev	HSR	Maglev	HSR	Maglev
<b><i>Standalone Primary Corridor (Portland to Vancouver)</i></b>						
Annual Ridership (millions)	1.8 – 2.0	1.9 - 2.1	1.8 - 1.9	1.8 – 2.0	1.6 - 1.7	1.6 - 1.8
O&M Subsidy per Passenger Mile	\$0.31 - 0.19	\$0.22 - 0.02	\$0.29 - 0.17	\$0.20 – 0.00	\$0.22 - 0.10	\$0.13 – 0.00
Rail Mode Share	13%	14%	17%	17%	15%	15%
Max Segment Load	0.30	0.31	0.32	0.33	0.27	0.29
<b><i>Total Network (Primary + Connecting E/W Corridor)</i></b>						
Ridership (annual)	2.2 - 2.5	2.3 - 2.6	2.1 - 2.4	2.2 - 2.5	1.9 - 2.2	2 - 2.3
O&M Subsidy per Passenger Mile	\$0.28 - 0.17	\$0.19 - 0	\$0.26 - 0.14	\$0.17 - 0	\$0.21 - 0.09	\$0.11 - 0
Max Segment Load	0.36	0.37	0.37	0.37	0.35	0.35

Source: AECOM derived from CONNECT results



Table 55-6. 2055 CONNECT Ridership Results

	Concept Corridor 1A Seven Stations		Concept Corridor 2 Four Stations		Concept Corridor 4 Three Stations	
	HSR	Maglev	HSR	Maglev	HSR	Maglev
<b><i>Standalone Primary Corridor (Portland to Vancouver)</i></b>						
Annual Ridership (millions)	2.9 - 3.2	3 - 3.3	2.7 - 3	2.9 - 3.2	2.5 - 2.8	2.6 - 2.9
% Increase in Ridership over 2035	61%	58%	54%	61%	60%	62%
O&M Subsidy per Passenger Mile	\$0.01 - 0	\$0 - 0	\$0.01 - 0	\$0 - 0	\$0 - 0	\$0 - 0
Rail Mode Share	13%	13%	16%	16%	15%	14%
Max Segment Load	0.45	0.47	0.46	0.48	0.40	0.42
<b><i>Total Network (Primary + Connecting E/W Corridor)</i></b>						
Annual Ridership (millions)	3.5 - 4	3.7 - 4.2	3.4 - 3.8	3.5 - 4	3.1 - 3.5	3.3 - 3.7
O&M Subsidy per Passenger Mile	\$0 - 0	\$0 - 0	\$0 - 0	\$0 - 0	\$0 - 0	\$0 - 0
Max Segment Load	0.6	0.61	0.61	0.61	0.58	0.58

Source: AECOM derived from CONNECT results

### 5.3.1 Primary Corridor – Portland to Vancouver

#### 5.3.1.1 Total Ridership and Rail Mode Share

Overall, the scenarios perform similarly across the corridors corresponding with the geographic coverage. Concept corridor 1A has seven stations, and has the highest ridership with approximately 2 million annual riders. Concept corridor 2 has similar results with only four stations, but they cover approximately 95 percent of the population covered in 1A. Concept corridor 4 has the lowest ridership estimates, with approximately 1.7 million, but is the only corridor of the three which does not include an airport connection. For the year 2055, there is approximately a 60 percent increase in ridership, indicating that the market will mature into a strong potential for UHSGT service.

Similar to the ridership, the rail mode share of the total intercity travel demand within the region does not change significantly across the corridors, but in all corridors, there is a strong rail mode share, ranging from 13 to 17 percent, which indicates a strong travel market penetration.

#### 5.3.1.2 Ridership by Market

Across all corridors, the Portland-Seattle market represents approximately half of the total ridership and is the driver for the corridor. The Seattle-Vancouver market is approximately 25 percent of the total, with the remaining station pairs making up the final 25 percent of ridership.

#### 5.3.1.3 Rail Mode Share and Max Segment Load

While the rail mode share is strong, the max segment load (indicating how full the train is at the maximum point in the system) across all corridors shows that the train is just over one-third full at the maximum point in 2035, and roughly 60 percent full at the maximum point in 2055. Therefore, it is not shown to be fully utilized based on the service provided. This warrants further detailed analysis since efficient transport services require maximum load points to be above 75 percent.

#### 5.3.1.4 Technology Type

Maglev operates at a faster speed (and therefore has shorter travel times) compared to HSR, and the ridership results show an increase of approximately 5 percent for maglev versus HSR across the

corridors. Given the high-level nature of this study, that difference maybe within the “margin of error”. Because of the lack of commercial costs for hyperloop, the significant travel time savings and its potential impact on ridership and revenue was indeterminate.

### 5.3.1.5 O&M Subsidy

HSR requires an operating subsidy across all corridors, while maglev approaches breaking even on operating costs at the high end of the forecast for 2035. By the year 2055, the operating subsidy is negligible regardless of technology or corridor.

## 5.3.2 Connecting Corridor – Seattle to Spokane

**Table 5-7** shows the results split by the primary corridor and the connecting corridor for 2035 and 2055. Adding in the connecting corridor does not have a major impact on the primary corridor ridership, but could add 300,000 to 400,000 in annual ridership across the corridors for 2035, which is an increase of 15 to 25 percent.

Table 5-7. Network Ridership Breakdown

	Concept Corridor 1A Seven Stations		Concept Corridor 2 Four Stations		Concept Corridor 4 Three Stations	
	HSR	Maglev	HSR	Maglev	HSR	Maglev
<b>2035</b>						
Primary Corridor (Portland - Vancouver)	1.8 - 2	1.9 - 2.1	1.8 - 2	1.9 - 2.1	1.6 - 1.8	1.7 - 1.9
Connecting Corridor (Seattle - Spokane)	0.4 - 0.5	0.4 - 0.5	0.3 - 0.4	0.3 - 0.4	0.3 - 0.4	0.3 - 0.4
<b>Total Network</b>	<b>2.2 - 2.5</b>	<b>2.3 - 2.6</b>	<b>2.1 - 2.4</b>	<b>2.2 - 2.5</b>	<b>1.9 - 2.2</b>	<b>2 - 2.3</b>
<b>2055</b>						
Primary Corridor (Portland - Vancouver)	2.9 - 3.2	3.0 - 3.3	2.7 - 3.3	2.9 - 3.2	2.5 - 2.8	2.6 - 2.9
Connecting Corridor (Seattle - Spokane)	0.6 - 0.8	0.7 - 0.9	0.7 - 0.5	0.6 - 0.8	0.6 - 0.7	0.7 - 0.8
<b>Total Network</b>	<b>3.5 - 4.0</b>	<b>3.7 - 4.2</b>	<b>3.4 - 3.8</b>	<b>3.5 - 4.0</b>	<b>3.1 - 3.5</b>	<b>3.3 - 3.7</b>

Source: AECOM derived from CONNECT results

## 5.4 Cost Estimates

This section describes the cost estimates from the final round of the CONNECT runs, which include both 2035 and 2055 forecasts for concept corridors 1A, 2, and 4 for both HSR and maglev technologies. The data presented in **Table 5-8** for 2035 and **Table 5-9** for 2055 are shown for both the standalone primary corridor (Portland to Vancouver) and the total network results (Portland to Vancouver plus Seattle to Spokane). This section discusses elements of the cost estimates and compares across dimensions (corridor, technology, and forecast year).

Table 5-8. 2035 CONNECT Cost Estimates

	Concept Corridor 1A Seven Stations		Concept Corridor 2 Four Stations		Concept Corridor 4 Three Stations	
	HSR	Maglev	HSR	Maglev	HSR	Maglev
<b>Standalone Primary Corridor (Portland to Vancouver)</b>						
O&M Cost Recovery Ratio	0.62 - 0.72	0.7 - 0.97	0.63 - 0.74	0.71 - 0.99	0.69 - 0.83	0.79 - 1.2
Total Cost Recovery Ratio	0.09 - 0.14	0.09 - 0.13	0.08 - 0.14	0.09 - 0.13	0.08 - 0.14	0.08 - 0.13

	Concept Corridor 1A Seven Stations		Concept Corridor 2 Four Stations		Concept Corridor 4 Three Stations	
	HSR	Maglev	HSR	Maglev	HSR	Maglev
Annual CapEx per Passenger Mile	\$3.14 - 4.62	\$3.59 - 4.53	\$3.21 - 4.7	\$3.69 - 4.77	\$3.29 - 4.92	\$3.85 - 4.95
Annual OpEx per Passenger Mile	\$0.78 - 0.76	\$0.58 - 0.67	\$0.75 - 0.73	\$0.56 - 0.65	\$0.66 - 0.65	\$0.45 - 0.57
<b>Total Network (Primary + Connecting E/W Corridor)</b>						
O&M Cost Recovery Ratio	0.5 - 0.62	0.58 - 0.83	0.51 - 0.64	0.59 - 0.85	0.54 - 0.69	0.63 - 0.97
Total Cost Recovery Ratio	0.09 - 0.14	0.09 - 0.13	0.08 - 0.14	0.09 - 0.13	0.08 - 0.14	0.08 - 0.13
Annual CapEx per Passenger Mile	\$2.74 - 3.64	\$3.14 - 3.61	\$2.77 - 3.66	\$3.18 - 3.75	\$2.85 - 3.86	\$3.34 - 3.92
Annual OpEx per Passenger Mile	\$0.82 - 0.75	\$0.61 - 0.66	\$0.78 - 0.73	\$0.58 - 0.64	\$0.72 - 0.68	\$0.51 - 0.59

Source: AECOM derived from CONNECT results

Table 55-9. 2055 CONNECT Cost Estimates

	Concept Corridor 1A Seven Stations		Concept Corridor 2 Four Stations		Concept Corridor 4 Three Stations	
	HSR	Maglev	HSR	Maglev	HSR	Maglev
<b>Standalone Primary Corridor (Portland to Vancouver)</b>						
O&M Cost Recovery Ratio	0.98 - 1.15	1.11 - 1.54	0.98 - 1.15	1.1 - 1.55	1.09 - 1.3	1.25 - 1.9
Total Cost Recovery Ratio	0.14 - 0.23	0.14 - 0.21	0.13 - 0.22	0.13 - 0.2	0.13 - 0.22	0.13 - 0.2
Annual CapEx per Passenger Mile	\$2 - 2.93	\$2.27 - 2.86	\$2.1 - 3.05	\$2.39 - 3.08	\$2.11 - 3.14	\$2.44 - 3.14
Annual OpEx per Passenger Mile	\$0.5 - 0.48	\$0.37 - 0.42	\$0.49 - 0.48	\$0.36 - 0.42	\$0.42 - 0.42	\$0.29 - 0.36
<b>Total Network (Primary + Connecting E/W Corridor)</b>						
O&M Cost Recovery Ratio	0.79 - 0.98	0.92 - 1.32	0.79 - 0.99	0.92 - 1.32	0.86 - 1.08	1.01 - 1.54
Total Cost Recovery Ratio	0.14 - 0.23	0.14 - 0.22	0.13 - 0.22	0.13 - 0.21	0.13 - 0.22	0.13 - 0.2
Annual CapEx per Passenger Mile	\$1.72 - 2.3	\$1.96 - 2.28	\$1.78 - 2.37	\$2.03 - 2.42	\$1.79 - 2.45	\$2.09 - 2.48
Annual OpEx per Passenger Mile	\$0.51 - 0.48	\$0.38 - 0.41	\$0.5 - 0.47	\$0.37 - 0.41	\$0.45 - 0.43	\$0.32 - 0.37

Source: AECOM derived from CONNECT results

### 5.4.1 Operating Cost Recovery

Similar to the ridership results, there is no significant difference in operating cost recovery across the corridors, but operating cost is a distinguisher between HSR and maglev. Maglev is cheaper to operate, but has slightly higher ridership due to faster travel times. Maglev will likely cover the operating costs, while HSR may require operating subsidies for the first 20 years or so.

### 5.4.2 Total Cost Recovery

The total cost recovery ratio incorporates the annualized operating and capital costs, and HSR has an advantage over maglev in this metric, as it is less expensive to construct HSR. Both maglev and HSR do not cover the annualized total costs, but HSR is more cost-effective.

### 5.4.3 Total Capital Investment

**Figure 5-3** shows the total capital investment ranges for each corridor and technology, and it can be seen that on the high end there is very little difference among the options. As noted previously, given the early development stage of Hyperloop, there were not commercial or revenue-tested operating or capital cost data to input into the CONNECT model. To not preclude any technologies at this stage, a high level of tunneling was assumed when developing generic corridor concepts. It is anticipated that as the engineering parameters of the Hyperloop technology are developed over time, the assumed required tunneling will be reduced and therefore the upper levels of the capital cost ranges in Figure 5-3 could be reduced substantially. The cost inputs specified for the two technologies, as well as the percentage of tunneling, are driving the overall costs. While Hyperloop is not analyzed, care was taken not to preclude this technology which also drives a portion of the higher end capital costs.

Concept corridor 2 is the highest, due to the construction cost distribution being skewed more towards urban construction versus rural (55 percent urban versus 45 percent rural), while the other two are slightly more rural (54 percent urban versus 46 percent rural). While the low end of HSR capital costs is lower overall than maglev, the range for HSR is greater, making the high end almost indistinguishable between the technologies.

The range of \$24-42 billion encompasses the needs of all three technologies at this high-level stage of analysis, including some that require very straight routes with minimum curvature and /or subgrade development with tunneling. A high percentage of tunneling was included as a capital cost input to the CONNECT model. When these capital parameters are narrowed down following a more detailed subsequent analysis of corridor alignments and technology, cost ranges could be reduced by 25 percent or more.

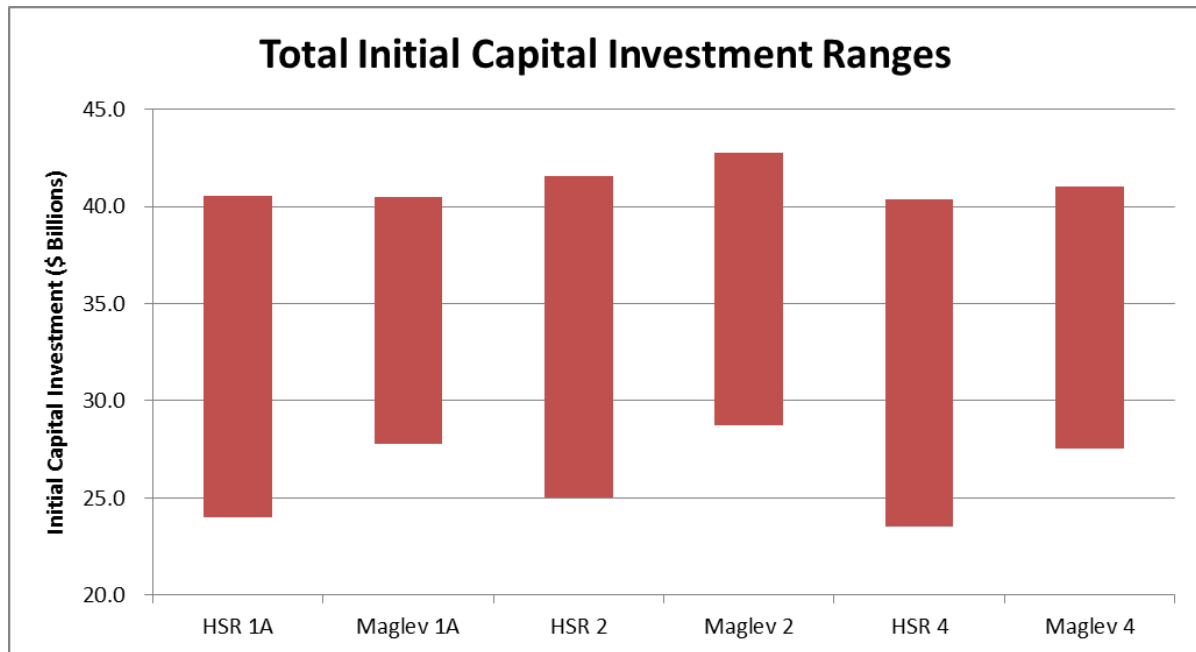

**Figure 55-3. Capital Investment Ranges by Corridor**  
 Source: AECOM derived from CONNECT results

**Table 5-10** summarizes the costs by category for each technology. Based on these costs, O&M is cheaper for maglev. There is no clear winner for capital costs between HSR and maglev, and station costs are only a small portion of the overall costs. One of the identifying features of concept corridor 4 was that it would not include any major stations, but that proved to not contribute enough to the overall costs to show a large difference.

Table 55-10. Estimated Cost Inputs by Technology

Cost Category	Maglev	HSR
Right-of-way Acquisition	\$1.7-\$27 million/mile (\$2.7-\$43.2 million/km)	\$2-32 million/mile (\$3.2-\$51.2 million/km)
At Grade Construction	\$45-\$52 million/mile (\$72-\$83.2 million/km)	\$15-\$35 million/mile (\$24-\$56 million/km)
Aerial Construction	\$93 million/mile (\$148.8 million/km)	\$123-\$200 million/mile (\$196.8-\$320 million/km)
Tunnel Construction	\$290 million/mile (\$464 million/km)	\$230 million/mile (\$368 million/km)
Trainset	\$50 million	\$36-\$41 million
Major Station	\$300 million	\$300 million
Minor Station	\$40 million	\$40 million
Maintenance Facility	\$212 million	\$120 million
O&M per Seat Mile	\$0.068-\$0.097/mile (\$0.108-\$0.155/km)	\$0.084-\$0.091/mile (\$0.134-\$0.146/km)
O&M per Route Mile	\$80-\$110 thousand/mile (\$128-\$176 thousand/km)	\$172-\$192 thousand/mile (\$275-307 thousand/km)

Source: CONNECT Tool defaults and consultant team estimates

#### 5.4.4 CONNECT Results Summary

This section provides a summary of the key CONNECT results and categorizes the results by regional geography/market, technological differentiation, and intercity travel mode share.

##### Regional Geography/Market Results

1. Given the limitations of the CONNECT model as well as the current trend lines, Seattle to Portland is critical to any future UHSGT alternatives. This high-level coarse model only predicts based on current trends and cannot accurately anticipate future significant changes in the economic relationships between Cascadia region markets. A more detailed ridership and revenue study is needed at a more precise level than that provided by CONNECT.
2. The CONNECT model, for all rail service levels (less than 79 mph [127 km/h], greater than 250 mph [402 km/h]), indicates that 12 round trips are the “sweet spot” for rail services before there are diminishing returns. The more detailed analysis identified in #1, is critical to determine the potential market. Such a study will also identify the impact of commuter and shorter intercity trips less than 50 miles (80 km), now excluded from the modeling.
3. Given that the current model indicates a market for 12 round trips, short of a major dedicated corridor investment, consideration should be given to analyzing the costs of additional service increases on the current corridor (Amtrak Cascades and Sound Transit commuter) as an interim step to build demand and the potential market share before embarking on building that new corridor.
4. While the East-West corridor to Spokane could add a 15 to 25 percent increase in network impact ridership, it requires initial subsidies to be viable.

5. The higher speed of maglev does not seem to significantly change the ridership/revenue equation. More detailed study is needed.
6. Given the very high capital costs for the Portland to Sacramento market as a Core Express dedicated corridor, and therefore a lessened opportunity to cover even O&M costs, it is recommended to discontinue future consideration in the 2035-2055 time-frame for this connecting corridor extension at the time of this study. California has not included a high-speed rail extension from Sacramento to Oregon in its recently released draft 2018 State Rail Plan. The California State Rail Plan does include references to potential high-speed rail connections to Las Vegas and Phoenix in the 2040 vision.

#### **Technology Differentiation Results**

7. In 2035, maglev seems to cover O&M costs in most alternatives; a small subsidy may be needed in the earlier period (2035) for HSR. By 2055, all corridor technological alternatives cover O&M and assist in capital carrying costs to various degrees.
8. While maglev and HSR have different capital and operating benefits over time, the CONNECT tool does not provide sufficient data to choose a specific technology at this time. More detailed technical analysis is required to select among the feasible technologies being examined.

#### **Intercity Travel Mode Share Results**

9. Both technologies have the potential to shift a significant share of the intercity travel market to rail. For these technologies at 12 round trips, 12 to 17 percent of the travel market by 2035 could be diverted to UHSGT.
10. Conversely, the utilization of capacity is relatively low, indicating an immature market or a model input limitation. As noted in #1, a more detailed analysis of how the market economies are changing needs to be completed to adequately predict future ridership and revenue.

# Implementing Ultra High-Speed Ground Transportation

## 6.1 Funding and Financing

High-speed ground transportation projects require substantial capital to cover initial construction costs, lifecycle costs (including maintenance), and operating expenses. Obtaining and identifying appropriate financing and funding resources is a key success factor in the construction and operation of a high-speed line.

This section summarizes feasible financing and funding options for the UHSGT project. The project team does not recommend any specific funding and financing options, but rather provides a high-level assessment of likely funding and financing study options and strategies for further analysis. The team also assessed (at a high level) the potential eligibility of the project to access specific U.S. Department of Transportation grant and loan programs, federal funding mechanisms, and infrastructure development programs such as the proposed Canada Infrastructure Bank (CIB).

## 6.2 Overview of Funding and Financing Models

High-speed ground transportation projects require substantial levels of capital expenditure as well as operating, maintenance, and lifecycle costs. In general, various public-private partnership (P3) models and their application in the U.S. and Canada were considered. Funding and financing are defined as follows:<sup>38</sup>

- **Funding** refers to the different sources of funds (other than those provided through financing) that can be used to pay for a project or service, such as farebox revenue, subsidies, and government grants. It also may include planned future taxes or levies. Funding can provide resources for operating costs, maintenance, lifecycle costs, and capital expenditure (CapEx).
- **Financing** refers to the tools used to access funds to pay for the CapEx of a project or service. Examples of financing mechanisms include debt (where loan capital is repaid over time), equity (direct investment, with a return to investors that reflects the level of risk), a mix of debt and equity, and other sources such as capital leases.

The potential financing and delivery models, along with the distribution of risk and responsibilities for each model, and some selected examples are shown across each component of the project lifecycle in **Figure 6-1**. In general, delivery models available for a UHSGT project include design-bid-build, design-build, private contract fee for service provision, design-build-operate-maintain, design-build-finance, design-build-finance-operate, and privatization. The selected financing/delivery model chosen for the UHSGT project should seek to achieve optimum risk transfer and highest value for money for the specific project under consideration. Several of the options shown in Figure 6-1 involve mixed public and private funding or financing (i.e. P3s).

---

<sup>38</sup>CH2M, 2017, *Ultra High-Speed Ground Transportation: Potential Funding and Financing Mechanisms*.

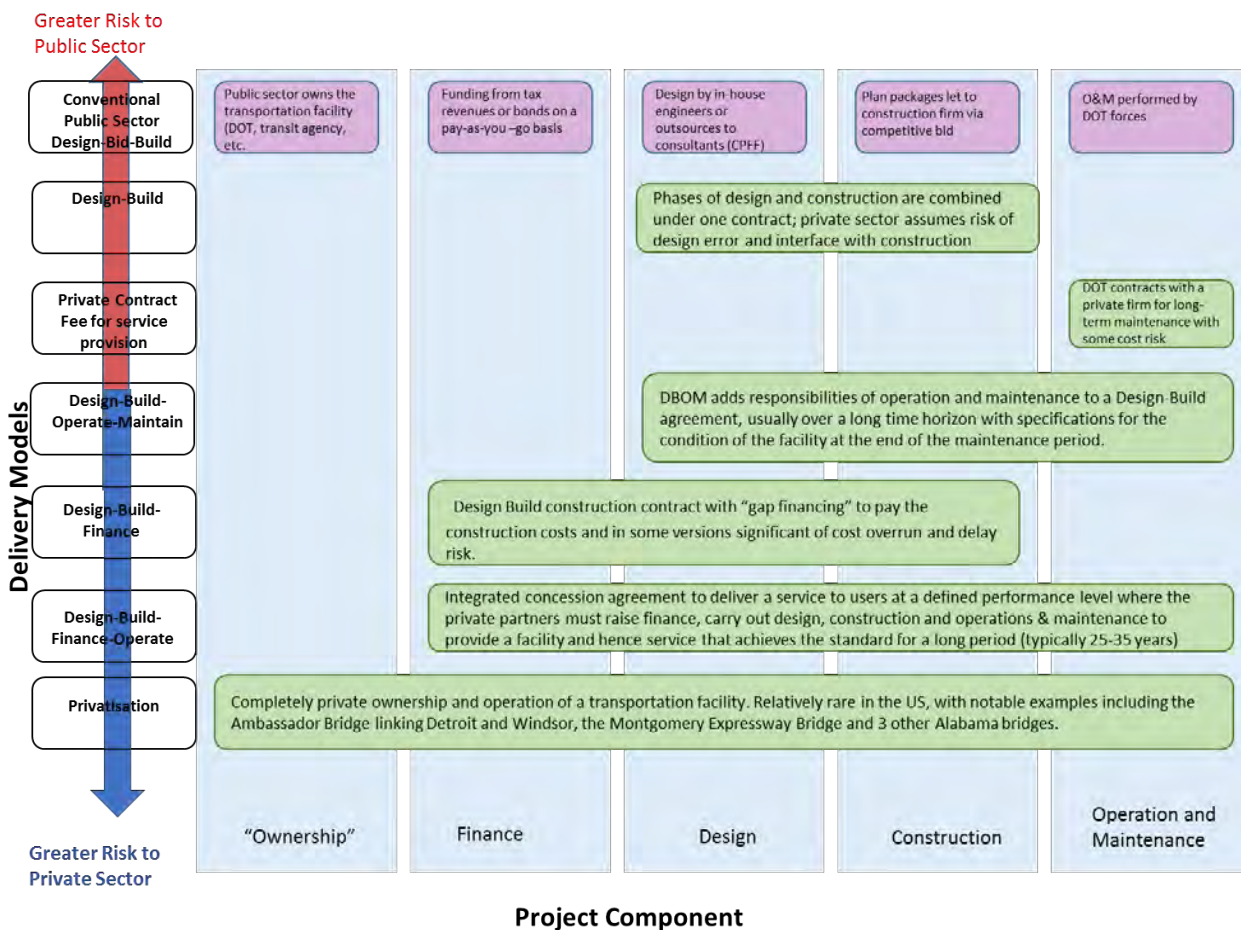

Figure 6-1. Financing and Delivery models - Distribution of Risk for Various Project Delivery Options  
 Source: CH2M, 2017, *Ultra High-Speed Ground Transportation: Potential Funding and Financing Mechanisms*.

### 6.2.1 Overview of Public-Private Partnerships

Traditional public-sector delivery of large-scale infrastructure projects often has been associated with cost overruns. The P3 model aims to procure infrastructure more efficiently by contractually allocating risks to the party that is best suited to manage them. Studies in Canada and elsewhere have shown that allocating risk properly in an infrastructure project leads to major cost and time savings both during construction and the operational life of the asset.<sup>39</sup>

There are two main sources of revenue and three main payment structures for P3 models. Sources of revenue include user fees (e.g., farebox revenue) and ancillary revenues (e.g., parking fees, commercial leases). Payment structures include construction payments, availability payments, and a construction-availability hybrid. The sources of revenue and payment structures are described below.

- **User Fees:** This refers to farebox revenue that is a direct payment by public riders on a passenger rail service. Fares may be subject to regulation by the public authority to cap fare increases for passengers. Often fare increases are tied to economic indicators such as the Consumer Price Index

<sup>39</sup> CH2M, 2017, *Ultra High-Speed Ground Transportation: Potential Funding and Financing Mechanisms*.



(CPI) or Gross Domestic Product (GDP) plus a defined percentage. The farebox revenue is typically used to cover the operation and maintenance expenditure costs.

- **Ancillary Revenues:** Ancillary revenues can be an important source of an overall financing package. It includes non-farebox revenue such as parking, retail food and consumer goods concessions, advertising, development rights (such as air rights over stations or other transit oriented developments), utility rights, and sponsorships.
- **Construction Payments:** If the public partner has the funds to cover construction costs, lump sum milestone payments or monthly “percentage complete” payments are used to pay for railroad construction projects. It is common practice for the government to hire an independent engineer to audit the work done by the private partner.
- **Availability Payments (Aps):** Availability payments are being made “available” to the private partner for the provision of a transportation “service” after achieving a certain level of performance. The private partner usually finances the design and construction costs and when the project is ready for operation, it receives regular availability payments (APs) to cover the construction costs. Under this structure, public funds should also be made available for operation and maintenance availability payments. These are usually monthly payments over the life of the concession.
- **Construction and Availability Payment Hybrid:** Under this mixed payment structure, public funds are made available (primarily for construction) to the private partner as either milestone or progress payments during the design and construction of the project.

## 6.2.2 United States Funding and Financing Programs

This section provides an overview of funding and financing programs in the United States and outlines the eligibility of an UHSGT project relative to each funding or financing program. There are public programs that can provide both funding and financing for transportation projects, including grants, credit programs, and in some cases carbon tax funding mechanisms. Table 6-1 summarizes funding and financing programs available for high-speed rail projects and the UHSGT project’s eligibility.

### 6.2.2.1 Public Funding and Financing Programs

Public funding programs include federal grants under the Fixing America’s Surface Transportation (FAST) Act and discretionary grants under the Transportation Investment Generating Economic Recovery (TIGER) and Infrastructure for Rebuilding America (INFRA) programs. The UHSGT project would in principle be eligible for two grant programs established under FAST or any other rail capital infrastructure programs authorized and appropriated by US Congress:

- “Consolidated Rail Infrastructure and Safety Improvements”. The fund has many types of potential spending that it is meant to support, such as research and improving multi-modal connections.
- “Federal State Partnership for State of Good Repair”, which is focused on repair or improvement of existing rail assets.

The project team analyzed the suitability and applicability of these rail capital infrastructure programs for the recent Texas-Oklahoma Passenger rail study<sup>40</sup>. As authorized in the FAST Act, these grant programs have potential authorization ranges between \$500 million to \$600 million. However, annual appropriations have remained much lower than the authorization levels. For example, in fiscal year

<sup>40</sup>CH2M and ESH Consult, “Texas – Oklahoma Passenger Rail Study, Service Development Plan”, March 2017, prepared for Texas Department of Transportation, in coordination with Oklahoma DOT.

2017, Congress only appropriated around \$93 million between the two programs combined. Both programs are constrained by a maximum level of 80 percent federal funding for each relevant project, with a minimum of 20 percent of project funding required from other sources, such as state governments. However, preference will be given to projects where the federal share is 50 percent or less.

In addition to these programs, the U.S. DOT awards discretionary grants under the Transportation Investment Generating Economic Recovery (TIGER) and Infrastructure for Rebuilding America (INFRA) programs. In fiscal year 2017, TIGER program awarded \$500 million in discretionary grants ranging between \$5 million and \$25 million. The FAST Act authorized the INFRA program, which focuses on highway and freight projects, and received an appropriation of roughly \$1,500 million between fiscal year 2017 and fiscal year 2018. TIGER and INFRA programs are not dedicated rail capital grant programs. These programs have much larger program goals and objectives. However, they do have significant amount of annual discretionary funding that could be used to finance eligible elements of the UHSGT. These authorized programs, in recent years, have not been appropriated at a level that would provide a significant federal capital contribution to a high-speed rail program.

Public financing programs include federal loans and credit programs such as the Transportation Infrastructure Finance and Innovation Act (TIFIA) and the Railroad Rehabilitation and Improvement Financing (RRIF) program. In 2015, President Obama established the Build America Transportation Investment Center, which is a resource for cities and states to collaborate with the private sector to support transportation infrastructure. It is commonly known as the “Build America Bureau” (BAB) and is housed in the U.S. Department of Transportation. The BAB administers both the TIFIA and RRIF programs. Additionally, the FAST Act aims to increase the level of P3 procurement in the U.S. The FAST Act authorizes and provides funding for large transportation projects for fiscal years 2016 to 2020; however, funds are currently obligated/appropriated on an annual basis.

The TIFIA program provides credit assistance for projects of regional and national significance. It provides three types of assistance:

- Secured (direct) loan: to be paid back within 35 years of project completion.
- Loan guarantee: where repayments to lender must begin within five years of project completion.
- Standby line of credit: to supplement revenues in the first ten years of operation.

All transit capital projects which qualify for Federal assistance with capital costs of more than \$50 million are eligible for support via the TIFIA credit program, up to a maximum of 33 percent of the total eligible project costs. Other key eligibility criteria under TIFIA stipulate that the project:

- Must be supported at least partially from user charges or other non-Federal dedicated funding sources;
- Should be included in the relevant State’s transportation plan; and
- Must have senior debt available as part-financing which is rated investment grade.

Eligible projects are evaluated by the US Secretary of Transportation against eight statutory criteria, including, impact to the environment; significance to the national transportation system; and the extent to which they generate economic benefits, leverage private capital, and promote innovative technologies.

Under the RRIF program, the Build America Bureau (BAB) is authorized to provide direct loans and loan guarantees up to a total of \$35 billion to finance development of railroad infrastructure. The maximum level of any individual grant is one-tenth of the total project costs. The fund may be used to develop

new railways facilities (stations, depots and track), such as new intercity routes similar to the conceptual UHSGT projects considered as part of this study.

The BAB expects to give funding priority to projects that provide public benefits, including benefits to public safety, environment and economic development. RRIF has provided major financial assistance to rail projects, such as a loan of \$2,450 million provided to Amtrak in 2016 for expenditure on infrastructure projects.

#### 6.2.2.2 Private Financing Programs & Foreign Infrastructure Banks

Private financing programs include Private Activity Bonds<sup>41</sup> (PABs) and foreign infrastructure banks. The PABs credit program is primarily focused on investment in freight transport and fixed crossings (such as bridges). Funds released must be spent on the relevant project within five years. As noted previously, the Brightline project in Florida recently sold \$600 million in PABs. Bonds are available for projects including, surface transport projects that require federal assistance; an international bridge or tunnel that is eligible for federal assistance; and any facility for the transfer of freight from road to rail or vice versa.

Several U.S. organizations have announced plans to enter into partnerships involving Chinese or Japanese finance for rail schemes. For example, Texas Central Railways, LLC has already accepted US\$40 million from the public-private Japan Overseas Infrastructure Investment Corporation for Transport and Urban Development. The new rail line from Dallas to Houston is projected to cost \$12 billion and to be completed by 2021 if it proceeds. Another example of possible Japanese financing is a proposed US\$10 billion high-speed maglev rail project planned to run from Baltimore to Washington. The Japan Bank for International Cooperation has pledged a US\$5 billion loan for the scheme.

Chinese initiatives in U.S. infrastructure financing have recently been complicated by transparency and regulatory issues, but there have been several recent purchases of Chinese rolling stock by operators such as the Chicago Transit Authority and the Los Angeles Metro. Given this landscape, we believe that Chinese or Japanese infrastructure financing options could be considered for the UHSGT project.

#### 6.2.2.3 Public-Private Partnerships (P3s)

The funding and financing programs described above can be combined through P3s to plan, construct, and operate large-scale transportation projects. Historically, U.S. states and municipalities have been relatively reluctant to use P3 models for procurement compared with some other developed countries such as Canada, the United Kingdom, and Australia. The legislative patchwork of P3 rules and decision-making by individual states in the U.S. poses a significant challenge to developing more public-private partnerships. For example, approximately 66 percent of states have their own P3 enabling legislation in the U.S. The UHSGT project is further complicated by not only multiple states, but also an international border. Further detailed study of statutory and regulatory hurdles is warranted.

Projects in the U.S. have access to one of the deepest and most liquid capital markets in the world. In the last 3 years, 371 infrastructure deals were completed in the U.S. Of these projects, 78 percent were solely financed by bank debt, 16 percent were funded with capital market financing such as bonds, and 7 percent were funded with a mix of both bonds and bank debt. Public-private partnerships in the U.S.

---

<sup>41</sup> As of the publication date of this report, the proposed Tax Cuts and Jobs Act of 2017, eliminates Private Activity Bonds as an available financing source.

also have included a wide range of levels of equity participation. Examples of these partnerships in the U.S. include the Indiana Toll Road and the Lyndon B. Johnson Freeway in Texas.<sup>42</sup>

### 6.2.3 Canadian Funding and Financing Programs

Canada has one of the world's most mature and stable P3 markets. Since 1993, over 177 public-private deals have been completed with support and funding provided by the federal government. However, the Canadian market is not only driven by the federal government alone, but is also promoted at the provincial and municipal level.

#### 6.2.3.1 PPP Canada

PPP Canada<sup>43</sup> specializes in P3s and is a world-class resource for P3 knowledge and expertise. Additionally, the P3 Canada fund also has played an important role for engaging municipal involvement in P3. Up to this point, the fund has invested in more than 20 public-private projects, leveraging C\$6 billion in capital expenditure. The success of the Canadian P3 market is in large part due to the strong political support that exists for P3 in Canada. This reduces political risks involved as procuring authorities, private investors, and creditors have confidence that the mechanisms within the P3 agreement will be enforced.

The Canadian P3 model provides an example model of best practices that the UHSGT project could adopt. Over 70 transportation infrastructure projects valued at more than C\$30 billion have been delivered since the financial crisis of 2008. However, due to the success of the program, PPP Canada will cease operations at the end of 2017 and will be dissolved effective March 31, 2018.<sup>44</sup>

#### 6.2.3.2 Canada Infrastructure Bank

The CIB, once fully operational, could provide a potential key source to finance major infrastructure projects such as the UHSGT project. The CIB could act as a center of expertise for advising all levels of government on infrastructure transactions involving private-sector investment.

---

<sup>42</sup> CH2M, 2017, *Ultra High-Speed Ground Transportation: Potential Funding and Financing Mechanisms*.

<sup>43</sup> <http://www.p3canada.ca/>

<sup>44</sup> CH2M, 2017, *Ultra High-Speed Ground Transportation*.

Table 6-1. United State Funding and Financing Programs and Eligibility

Funding Program	Project Eligibility	Funding Available (U.S. Dollars)	Actual Funding Distribution (U.S. Dollars)
FAST Act	Eligible for the “Consolidated Rail Infrastructure and Safety Improvements” and the “Federal State Partnership for State of Good Repair” programs.	\$500 to \$600 million	\$93 million (FY17)
Transportation Investment Generating Economic Recovery (TIGER)	TIGER and INFRA programs are not dedicated rail capital grant programs; however, these programs do have a significant amount of annual discretionary funding that could be used to finance eligible elements of the UHSGT.	\$500 million (FY17)	\$5 to \$25 million per project
Infrastructure for Rebuilding America (INFRA)		\$1.5 billion (FY17-FY18)	Not Available
Transportation Infrastructure Finance and Innovation Act (TIFIA)	All transit capital projects qualifying for federal assistance with capital costs of more than \$50 million are eligible for support via the TIFIA credit program.	33% of eligible project costs	Projects funded FY17: <ul style="list-style-type: none"> <li>• \$1,330 million - East Link Extension (Seattle, WA)</li> <li>• \$538 million - Mid-Coast Corridor (San Diego, CA)</li> <li>• \$307 million - Westside Purple Line Extension (Los Angeles, CA)</li> </ul>
Railroad Rehabilitation Improvement and Financing program (RRIF)	Funds may be used to develop new railway facilities (stations, depots, and track), such as new intercity routes similar to the UHSGT project.	Loans up to 35 billion, grants up to \$3.5 billion	Not Available <sup>45</sup>
Private Activity Bonds (PABs)	The PABs credit program is primarily focused on investment in freight transport and fixed crossings (such as bridges). All TIFIA projects are eligible and have included public transport and intercity rail.	\$4.1 billion	Projects funded FY17: <ul style="list-style-type: none"> <li>• \$600 million – Brightline (Miami to West Palm Beach, FL)<sup>46</sup></li> </ul>

Source: CH2M, 2017, *Ultra High-Speed Ground Transportation: Potential Funding and Financing Mechanisms*.

<sup>45</sup> FRA indicates that the Brightline project may apply for federal loans under RRIF for further expansion from West Palm Beach to Orlando. See Federal Rail Administration, “All Aboard Florida – Miami to Orlando Passenger Rail Service”. <https://www.fra.dot.gov/Page/PO819> Accessed on December 12, 2017.

<sup>46</sup> Roustan, W.K., “New Brightline express trains to roll in December, report says”, Sun Sentinel, November 28, 2017. <http://www.sun-sentinel.com/news/transportation/fl-reg-brightline-start-20171128-story.html> Accessed on December 12, 2017.

The Budget Implementation Act was passed on June 22, 2017, and implements the CIB. The Canadian government is currently recruiting key senior-level personnel and aims to launch the CIB in late 2017. The CIB's mandate is to invest \$35 billion into projects where the CIB's participation will serve as a catalyst for new forms of additional private investment into infrastructure in Canada or partly in Canada (i.e., potentially projects with a physical link to the U.S.).

The CIB will invest strategically, prioritizing transformative projects including public transit plans and transportation networks. Project screening criteria are expected to be on a project-by-project basis, but a complete description of funding screening criteria has not been shared publicly. **Table 6-2** outlines high-level criteria based on the currently available public information.

Table 6-2. CIB Investment in Ultra High-Speed Ground Transportation

#	Potential Screening Criteria for Investment (based on currently available information)	Meets Criterion	Likely Meets Criterion	Unlikely Meets Criterion	Further Investigation Required
<b>Strategic Criteria</b>					
1	Is UHSGT in the public interest?		✓		
2	Does UHSGT have a public sponsor?	✓			
3	Is UHSGT a transformative project?	✓			
4	Is UHSGT a public transit and transportation project?	✓			
5	Will UHSGT foster evidence-based decision-making?	✓			
6	Is UHSGT a highly complex project?		✓		
7	Is UHSGT in Canada or partly in Canada (i.e., physical U.S. link)?	✓			
<b>Financial and Commercial Criteria</b>					
8	Does UHSGT generate revenue?		✓		
9	Will UHSGT deliver a return?				✓
10	Will UHSGT attract private sector capital?				✓

Source: CH2M, 2017.

The CIB will serve as a catalyst for new forms of private investment for infrastructure in Canada (or partially located in Canada). The UHSGT project meets the CIB's strategic criteria, based on a preliminary assessment, and the project could satisfy financial and commercial requirements for investment. The CIB increases the financing options available for UHSGT when compared to current forms of financing, and could increase the likelihood of successful procurement and delivery of the project.

#### 6.2.4 International Funding and Financing Models

This section describes key elements of five recent international rail projects<sup>47</sup> and identifies the critical mechanisms necessary to procure a large transportation project such as the UHSGT project. **Table 6-3** summarizes international HSR rail projects and identifies lessons learned that could be applied in the development of the UHSGT project.

<sup>47</sup> CH2M, 2017, *Ultra High-Speed Ground Transportation: Potential Funding and Financing Mechanisms*.

Table 6-3. International High-Speed Rail Case Studies

Case Study Name	Project Facts	Funding/Financing Mechanism	Relevance to the UHSGT Project
Perpignan to Figueres HSR (France to Spain)	The governments of France and Spain constructed a new HSR line under a P3 agreement.	80% of the project was financed by bank debt totaling \$679 million (an equal split of 6 different mandated lead arrangers) and government contributions of \$1,379 million (equally split between the French and Spanish Governments).	The case study is important for UHSGT partners as it highlights potential risks that could be faced by governments when entering P3 agreements.
Intercity Express Program (IEP) Phase 2 HSR (United Kingdom)	The IEP has been procured by the United Kingdom (UK) Department for Transport as a Design, Build, Finance, and Maintenance PPP valued at £5.7 billion. The project is procured in two phases and will replace the aging intercity high-speed trains on the East Coast Main Line, which travels from London to Edinburgh, and the Great Western Main Line.	Phase 2 of the IEP financing is leveraged at 90%. The financing included £2.2 billion senior term loan split between 10 commercial lenders, Japan Bank for International Cooperation, and the European Investment Bank.	This is an innovative P3 project that shows how the government can incentivize the private sector to deliver the rolling stock for the long-term future of the rail system. The IEP P3 leveraged new sources of finance while also minimizing the impact on the government's budget.
Taiwan HSR	Taiwan HSR is the first HSR system in Asia and the largest build-operate-transfer infrastructure project in the world.	Bank debt amounted to \$323 billion, which was provided by 25 local banks and was solely guaranteed by the forecasted HSR operating revenue. The Ministry of Transportation and Communications, Taiwan High Speed Rail Corporation, and the bank consortium signed a "three-party contract" that specified the procedures that had to be followed in the case of a termination of the build-operate-transfer contract.	The case study indicates how operating revenue could be used to potentially raise debt from commercial and infrastructure investment banks.
Tours-Bordeaux HSR (France)	The HSR from Tours to Bordeaux links up with another HSR running to Paris. The HSR was procured as a 50-year P3 concession.	The project has an 80:20 debt-to-equity ratio. The project faced difficulty raising capital because of the financial crisis affecting the Eurozone in 2012. To help the project go through, the French government and the local authorities involved contributed subsidies to the project worth of €3 billion.	Preliminary results indicate that farebox revenue from UHSGT should be adequate to cover the operating expenses of the projects, but will not cover all the initial capital invested. This shows that government funding will likely be essential for the project to go forward.

SECTION 6. IMPLEMENTING ULTRA HIGH-SPEED GROUND TRANSPORTATION

Case Study Name	Project Facts	Funding/Financing Mechanism	Relevance to the UHSGT Project
Eglinton Crosstown Light Rail Train (LRT) (Canada)	The Eglinton Crosstown LRT is part of Metrolinx’s regional transportation plan that aims to reduce congestion in Toronto. The line will run along Eglinton Avenue with about half the distance running underground, with links to bus routes, three subway stations, and various GO Transit lines (regional public transport).	The LRT was delivered as a design-build-finance-and-maintenance P3 model. The duration of the concession agreement is 30 years.	This case study indicates the liquid Canadian capital sources that the UHSGT project could have access to. The introduction of bank debt will require due diligence that may benefit UHSGT.
Gotthard Rail Link (Switzerland)	The Gotthard rail link is the world’s longest rail tunnel. The link became operational in 2016. Swiss Federal Railways is responsible for the operation and governance of the rail link.	All financing responsibilities for the Gotthard rail link lie with the Swiss government. The financing structure for the link is primarily based on revenue streams from other transport operations, backed by Swiss government borrowing capacity. In 2008, the Swiss parliament approved a budget of CHF 13.2 billion (around US\$13 billion at current exchange rates) for the Gotthard rail link.	This case study shows how a government can raise funds for both infrastructure and rolling stock through the taxing of motorized transport and through sales tax, when a project is sufficiently high profile to ensure political and public backing. This project did not rely on P3 or alternative sources of finance.

Source: CH2M, 2017, *Ultra High-Speed Ground Transportation: Potential Funding and Financing Mechanisms*.



## 6.2.5 Summary of Learned Lessons

Given the case studies examined and the analysis of the Canadian, U.S., and international markets, there are five key lessons applicable to the UHSGT project. They are outlined below.

### **1. Strong political support to progress private sector/P3 financing**

If the project is to be procured under a P3 partnership, it will need strong political support from all governments involved. In Canada, the existence of strong political support is essential to a successful and thriving P3 market. Conversely, an absence of support can significantly hinder the development of a mature P3 market. Political risk is one of the greatest risk factors associated with infrastructure investment and a primary reason for reluctance by the private sector to invest in infrastructure projects.

This process does not depend primarily on the federal government. Canada's experience demonstrates that generating strong political support at the provincial and municipal level, along with established P3 legislation, is a key step towards successfully procuring a project, such as the UHSGT project, under a P3 agreement.

### **2. Strong and broad supply of infrastructure capital (capital market)**

The existence of a strong, liquid capital market is essential to securing capital investment for infrastructure deals. This is illustrated both in the U.S. and the Canadian market. As evidenced in the Eglinton Crosstown LRT case study, the project could generate over \$1 billion of private financing that included bank financing, equity contributions from the consortium, and access to capital markets without the need for any government contribution. This indicates that there is a strong supply side that should be potentially interested in investing in the UHSGT project.

Building on this argument, it is important to engage the industry during the early stages of a project. For instance, according to MyHSR (Malaysia), the government agency responsible for the Kuala Lumpur-Singapore HSR, obtaining industry feedback is key to ensure a successful tender. It issued a Request for Information as a market-sensing exercise to refine and validate options to ensure a successful tender process. It recently organized two industry briefing sessions (in Singapore and London), which were attended by representatives from about 300 international and local entities, in which topics such as financing, technical issues, program, and timeline were discussed along with other general concerns.

### **3. Government guarantees and infrastructure bank support**

The Tours-Bordeaux HSR case study illustrates the importance of institutional and governmental support in the form of government-backed debt. The involvement of an infrastructure bank or the contribution of a state subsidy could be determinants in mobilizing private investment in an HSR deal. This could be particularly important in the UHSGT project as the high CapEx required implies that the project may require significant ridership to achieve financial returns. This could be a deterrent for private investors; however, contributions from government subsidies, a government-backed debt, or the involvement of the CIB could encourage private investments.

### **4. Established procurement and delivery models**

Efficient and established procurement methods are another key factor in a successful P3 agreement. Most P3 activity is seen in areas where there are established procurement processes, such as Europe (particularly in the United Kingdom and France), Australia, and Canada. This is another area where the project can benefit from the Canadian practice. At the project level, ensuring that there is a trusted partnership is fundamental to successful project delivery. To achieve this, it is important for both parties to provide transparent and objective information about the level of performance under the contract.

### 5. Understanding of key delivery and operational risks

A successful financial and business case for major transportation infrastructure projects relies on robust analysis of delivery and operational risks. Three risks—revenue risk, construction risk, and technical/integration risk—should be assessed to identify the financial condition of a project. The France-Spain project illustrates some of the consequences of not assessing these risks fully, particularly revenue risk and technical integration risk.

The risks are described below:

- **Revenue risk:** The risk that project revenues—from user charges or other sources—are materially different from forecast revenues, particularly if actual revenues are much lower than forecast, resulting in a lower fare recovery ratio.
- **Construction risk:** Effective management of project schedule and budget, with appropriate transfer of risk to the private sector, is fundamental to the success of infrastructure investment projects.
- **Technical/integration risk:** Rail systems are particularly affected by this risk because of the necessity of integrating the project with civil infrastructure assets and connecting new rail routes with existing infrastructure.

## 6.3 Cross-Border Issues

This section provides a high-level overview of existing governance models that are commonly used for multi-state infrastructure projects in the U.S.

Cross-border and multi-state infrastructure projects require extensive coordination between the relevant countries and/or states, and other key stakeholders. An effective governance structure should support long-term investment across a range of financing options and delivery models. Coordination must cover several complex issues related to planning and development of the overall business case, while at the same time considering each state/country's technical standards and regulatory, financial, political, and institutional requirements.

Best practices illustrate that successful cross-border HSR projects have a governance structure with clear lines of authority, responsibility, and a mandate to facilitate the coordination and implementation of the project across the two different jurisdictions. **Table 6-4** outlines eight multi-state governance models used in the U.S. for developing and progressing passenger rail projects for different phases of project development, drawing on the work carried out for the FRA Southeast Regional Rail Study.<sup>48</sup>

Table 6-4. Description of Alternative Multi-State Governance Models

No.	Model	Definition	Phase of Development	Examples
1	Coordinated State Efforts	Where two or more states agree to coordinate passenger rail efforts within their respective states.	Visioning Planning	Pacific Northwest Rail Corridor (Amtrak Cascades, see subsequent section) South Central High-Speed Rail Corridor
2	Coalition/ Partnership	Where multi-state partners convene on a voluntary basis to carry out activities of common interest. May also be carried out in coordination with a non-profit corporation.	Visioning Planning	Midwest High-Speed Rail Steering Group I-95 Coalition Coalition of Northeastern Governors Midwest Regional Rail Initiative Steering Committee Amtrak Northeast Corridor (NEC) Infrastructure Master Plan Working Group

<sup>48</sup> CH2M, 2017, *Ultra High-Speed Ground Transportation: Cross Border Issues*.

Table 6-4. Description of Alternative Multi-State Governance Models

No.	Model	Definition	Phase of Development	Examples
3	Single State Agency Contracting with or on Behalf of Other States	Where an existing or newly created entity within a single state addresses multi-state interests, primarily through contractual arrangements with other states.	Design Construction Operations and Maintenance	Chicago-Detroit/Pontiac Corridor Northern New England Passenger Rail Authority
4	Public-Private Partnership	Where the government and the private sector enter into an arrangement that allows for greater private-sector participation in the delivery of transportation projects.	Design Construction Operations and Maintenance	All Aboard Florida Texas Central Railway Indianapolis-Chicago Hoosier State Service
5	Multi-State Commission	Where two or more states coordinate multistate interests through a formal agreement that establishes a governing body.	Planning Preliminary Design	Southeast High-Speed Rail Corridor Project: Virginia-North Carolina Midwest Interstate Passenger Rail Commission
6	Multi-State Special Authority	Where an independent entity, often a distinct governmental body, delivers a limited number of public services within defined boundaries across state lines and can exercise a broad range of typical governmental powers.	Design Construction Operations and Maintenance	Washington Metropolitan Area Transit Authority Port Authority of New York and New Jersey
7	Federal-State Commission	Where a body of federal, state, and, sometimes, local leaders organize to address a critical need.	Planning	Appalachian Regional Commission NEC Infrastructure Operations and Advisory Commission
8	Freight Railroads	Where freight railroads lead delivery of passenger rail services.	Design Construction Operations and Maintenance	No current examples

Source: CH2M, 2017, *Ultra High-Speed Ground Transportation: Cross Border Issues*.

## 6.4 U.S.–Canadian Cross-Border Arrangements

This section considers selected case studies for current cross-border arrangements for links between the U.S. and Canada, to inform possible arrangements for cross-border high-speed services.

Canada and the U.S. are major trading partners: in 2015, Canada was the largest export market for the U.S. and the second largest importer. There are various transportation modes that enable the flow of goods between the two countries, and, across the Washington state and British Columbia border. WSDOT has stewardship responsibilities for ground transportation within Washington, and has influence over cross-border transportation services with BC. Similarly, the Ministry of Transportation and Infrastructure for British Columbia has stewardship and planning responsibilities for most ground transportation services within, or originating within, British Columbia.

In this context, some relevant current U.S.-Canada cross-border governance arrangements were considered, drawing mainly on current practice and examples, while noting regulatory arrangements and any controls on cross-border movements for each example described.

### 6.4.1 Amtrak Cascades Rail Service

Amtrak Cascades is the current passenger rail service that operates in the northwest corridor between the U.S. and Canada (Eugene, Oregon, to Vancouver, BC). The service is owned by the states of Washington and Oregon and operated by Amtrak (the U.S. National Railroad Passenger Corporation) in partnership with British Columbia, over rail infrastructure owned by different “host railroads” that are large publicly traded companies, such as UPRR in the U.S., and the Canadian National Railway.<sup>49</sup> Amtrak pays these rail infrastructure managers for access to their tracks and supporting infrastructure; access in the U.S. is on an incremental basis based on U.S. statutory requirements.

The funding of the service is primarily through the states of Oregon and Washington. In 2013, the U.S. government shifted responsibility for funding the Cascades service to the states to comply with the Passenger Rail Investment and Improvement Act (PRIIA) of 2008. As a result, the Cascades services are funded through farebox revenue and state funds. Washington funds most of the services; as of December 2017, this funding covers six daily round trips between Seattle and Portland. Washington also funds two daily round trips between Seattle and Vancouver, BC. Oregon funds two daily round trips between Eugene and Portland.

U.S. passengers traveling to Vancouver do not need to disembark for an immigration inspection at the Canadian border, as they pass through Canadian customs at Vancouver Pacific Central station when they arrive. Amtrak has an agreement with British Columbia that allows north bound trains to pass through the U.S. - Canadian border without stopping. Importantly, the agreement improves the passenger experience, as it reduces delays at the international border and allows faster connections because passengers can exit their station immediately after arriving.

As of 2016, the Cascades service has a farebox recovery ratio of 59 percent and is the eighth busiest U.S. passenger route with a total annual ridership of 817,000.<sup>50</sup> The Cascades service has an on-time performance target of 88 percent, with a running time of approximately 9 hours between Portland and Vancouver over the 344-mile (554-km) distance. Given the economic strength of the region and the projected population growth, there is a tremendous opportunity for a new high-speed system to provide a higher-quality and more time-efficient service.

Similar arrangements and governance models are used for other Amtrak cross-border passenger services between the U.S. and Canada, including the Maple Leaf service from New York City to Toronto and the Adirondack service from New York City to Montreal. However, these services do not benefit from a border pre-clearance facility, with negative impacts on journey time and passenger experience.<sup>51</sup>

### 6.4.2 St. Lawrence Seaway (Joint Commission)

The St. Lawrence Seaway is a system of locks, canals, and channels that cross eastern Canada and the northeastern U.S., from Lake Ontario to the Atlantic Ocean. It facilitates transport of cargo ships from the Atlantic Ocean to the end of Lake Superior.

Some of the locks are managed by the St. Lawrence Seaway Management Corporation in Canada, while others are managed by the St. Lawrence Seaway Development Corporation in the U.S. The river section downstream of Montreal, which is fully within Canadian jurisdiction, is regulated by the offices of Transport Canada in the Port of Quebec.

An International Joint Commission was established in 1954. It helps with dispute settlement regarding the use of boundary waters and provides advice to Canada and United States on issues related to water resources. The joint commission decisions are not binding; it merely offers recommendations to both

<sup>49</sup> CH2M, 2017, *Ultra High-Speed Ground Transportation: Cross Border Issues*.

<sup>50</sup> CH2M, 2017, *Ultra High-Speed Ground Transportation: Cross Border Issues*.

<sup>51</sup> CH2M, 2017, *Ultra High-Speed Ground Transportation: Cross Border Issues*.

governments. Even though the recommendations are not binding, they are usually accepted by both governments.

### 6.4.3 Ferry Services Between Washington State and British Columbia

There are five separate ferry operators that provide direct services from Washington state to Victoria, B.C. These involve traditional ferries, high-speed ferries, passenger-car ferries, and passenger-only ferries. The Washington ferry network is the largest in the U.S.; it has 20 terminals and 10 routes servicing 10.5 million vehicles and more than 23 million people annually.<sup>52</sup> British Columbia Ferries (BC Ferries) is a publicly owned company subsidized by the BC government and the federal government of Canada. It provides a range of major passenger and vehicle ferry services between BC and Washington.

There is no single entity that governs or regulates these maritime services. All operators, either state-owned or private, comply with the existing collaborative law enforcement that exists between the U.S. and Canada regarding lawful travel and trade. Since 2009, passports are required for all border crossings. A brief identification check is carried out on all passengers before boarding the ferry, but passengers pass through customs and immigration at the destination country.

### 6.4.4 Coach Services Between Washington State and British Columbia

Greyhound Lines, commonly known as Greyhound, is an intercity bus serving almost 4,000 destinations within North America. Greyhound offers a service from Seattle to Vancouver, and an express bus (“Bolt Bus”) from Seattle to Portland. Other private operators of cross-border coach services include Quick Shuttle. As with the ferry services, there is no single entity that controls and regulates the coach services. While these services can be marginally faster and cheaper than the current Amtrak service, they are often also subject to traffic congestion along their route, which is likely to worsen as traffic increases.

There are 13 roadway border crossings between Washington and British Columbia. The most highly used of the 13 are the four westernmost crossings near Vancouver. Coaches (and all other road traffic) are subject to full border controls at each of these crossings.

## 6.5 Selected International Examples of Governance Models for High-Speed Rail

### 6.5.1 London–Paris High-Speed Rail

The London–Paris HSR route is an example of a vertically separated railway, with several service operators and infrastructure managers under an overall governance framework mandated by the European Commission, which applies to both the UK and France.<sup>53</sup>

HS1 is the UK infrastructure manager of 109 km of high-speed track running from London’s St. Pancras International Station to the Channel Tunnel. SNCF Réseau is the French infrastructure manager responsible for the rail network between the Channel Tunnel and Paris, and for almost all other rail infrastructure within France. Eurotunnel is the infrastructure manager for the Channel Tunnel. The revenue stream for all three infrastructure managers is primarily in the form of access fees that the operating companies (OpCos), in particular Eurostar, pay to use the track and associated facilities (such

---

<sup>52</sup> CH2M, 2017, *Ultra High-Speed Ground Transportation: Cross Border Issues*.

<sup>53</sup> CH2M, 2017, *Ultra High-Speed Ground Transportation: Cross Border Issues*.

as signaling and electrification systems). Eurostar is the international operator of passenger services between London and Paris/Brussels.

A trans-European regulatory and governance framework has been developed by the European Commission, which applies equally to HS1, Eurotunnel, SNCF Réseau, Eurostar, and other operators such as freight companies. Additionally, the British and French governments have certain rights and responsibilities for the Channel Tunnel and cross-border services, primarily relating to safety, security, and land ownership, implemented originally through the 1992 Treaty of Canterbury. The overall governance framework, illustrated in **Figure 6-2**, provides for regulation of passenger rail services between the two countries, and constrains and defines cash-flow streams between the key stakeholders.

As can be seen in Figure 6-2, a concession agreement was originally granted to Eurostar by the two governments. Eurostar has entered into access agreements with the infrastructure managers, under which Eurostar is responsible for paying access charges to the three infrastructure managers. To constrain monopoly power and produce incentives for efficiencies, the infrastructure managers are regulated by British and French economic regulators as shown below. The joint Inter-Governmental Commission (IGC) retains certain responsibilities as the economic and safety regulator of the Channel Tunnel. However, it has in practice delegated most of its economic regulation responsibilities to the UK regulator, the Office of Rail and Road (ORR).

Under a system known as “juxtaposed controls” agreed between Belgium, France, and the UK, pre-clearance immigration checks for Eurostar cross-channel services take place before boarding the train, rather than upon arrival. Immigration entry checks are carried out at UK stations before embarkation by the French Border Police. When traveling from Belgium or France to the UK by Eurostar, passengers clear immigration through exit checks from the Schengen Area, as well as UK immigration entry checks, before boarding the train. However, on Eurostar during customs checks passengers remain, and continue to take place upon arrival after leaving the train.

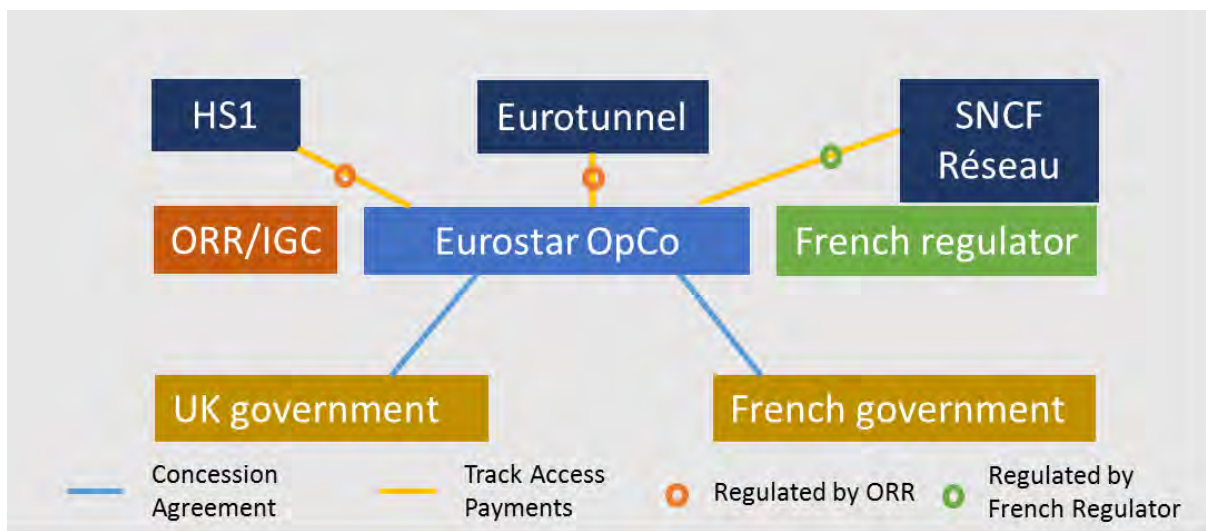

Figure 6-2. Governance and Regulatory Framework for London-Paris HSR Passenger Services  
Source: CH2M, 2017, *Ultra High-Speed Ground Transportation: Cross Border Issues*.

## 6.5.2 Kuala Lumpur–Singapore High-Speed Rail

The Kuala Lumpur (KL) to Singapore High Speed Rail line is a proposed 350-km cross-border high-speed rail link between Malaysia and Singapore that is due to be operational by 2026. The travel time from KL to Singapore should be reduced to 90 minutes compared to the current rail travel time of up to 7 hours. The project will deliver eight new stations, with seven in Malaysia and one in Singapore.

The governance model for the KL–Singapore HSR system considers the agreed delivery model, the system’s operational characteristics, and the overall regulatory and market environment in the countries involved. This governance model is presented in **Figure 6-3**. As can be seen in Figure 6-3, similar to the St. Lawrence Seaway, there is a bilateral agreement between the two countries to establish a joint commission, the “Bilateral Committee,” which consists of representatives of both governments. The Bilateral Committee is responsible for regulation and management of the compliance framework for access to the HSR infrastructure and assets, the certification and licensing needed, and the harmonization between the two countries (including the dispute settlement process).

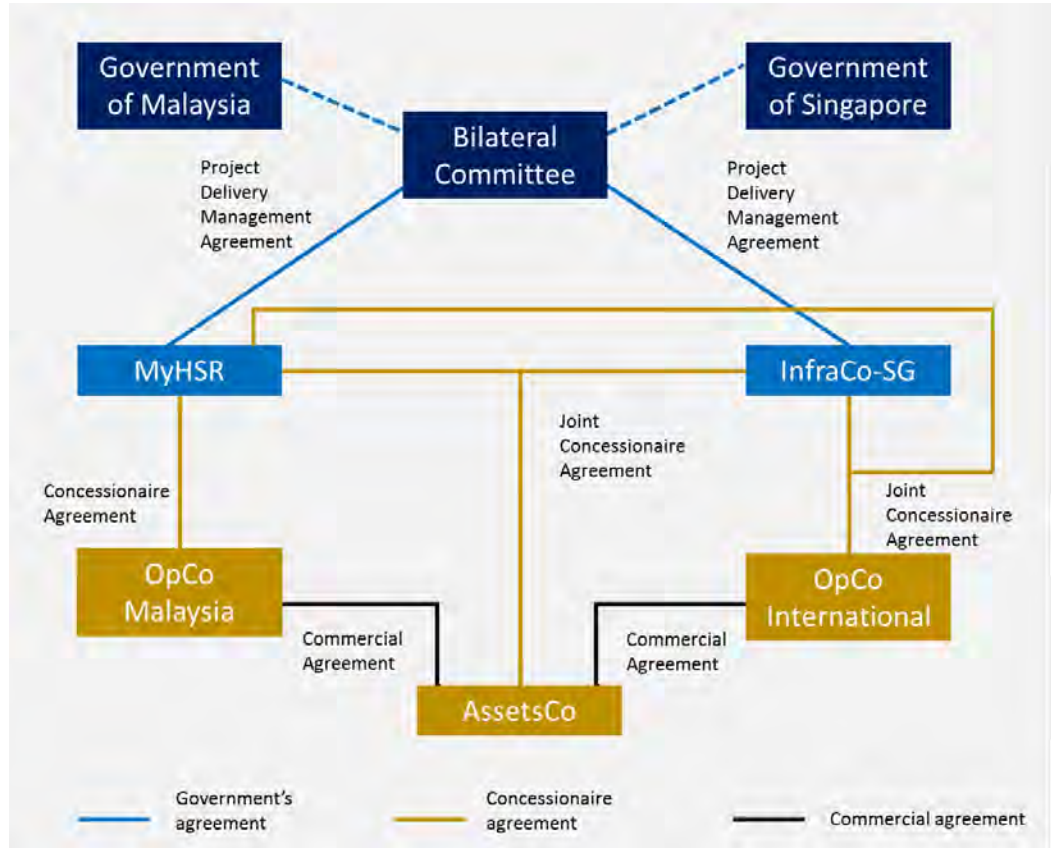

Figure 6-2. Regulatory Framework for Kuala Lumpur–Singapore HSR line

Source: CH2M, 2017, *Ultra High-Speed Ground Transportation: Cross Border Issues*.

As with the European model used for London–Paris services, for the KL–Singapore HSR line there is a vertical separation of infrastructure managers and operating companies. One key difference between the KL–Singapore model and the London–Paris model is that, as can be seen in Figure 6-3, the infrastructure managers outsource the operation of most rail assets to the assets company (AssetsCo). Commercial access agreements are envisaged between AssetsCo and the OpCos, under which the AssetsCo allows access to the OpCos in return for access payments.

The Malaysian and Singaporean governments have agreed on a set of arrangements for CIQ (Customs, Immigration and Quarantine) to provide pre-clearance checks for international passengers between KL and Singapore at the relevant departing station; for example, passengers boarding at KL for the direct express service to Singapore would clear customs and border checks at CIQ facilities in the new Bandar, Malaysia international station in KL. However, passengers boarding at domestic Malaysian stations to travel to Singapore will need to disembark at Iskandar Puteri station in Southern Malaysia, where the domestic service terminates. CIQ checks will then be carried out at Iskandar Puteri station before passengers can board a short shuttle service to Singapore. The same arrangements apply in reverse for passengers traveling from Singapore to domestic Malaysian stations.

### 6.5.3 France-Spain New High-Speed Line under a P3 Model: Perpignan to Figueres

This HSR project involved the development of a 45-km high-speed link from Perpignan (France) to Figueres (Spain), including an 8-km tunnel to pass through the Pyrenees. The concession was awarded at the beginning of 2004. The line was constructed under a P3 agreement that involved the winning consortium TP Ferro (a joint venture between two construction companies, Eiffage from France and ACS from Spain) and the two governments. More than half of the CapEx was equally funded by the two governments, while the remaining CapEx was provided through equity from the TP Ferro shareholders and through bank debt. TP Ferro's revenues were from track access and energy supply charges, both of which are related to the traffic levels of the line.

The initial HSR passenger traffic was around 35 percent of the level forecast by the concessionaire, mainly due to capacity issues and significant competition from air services due to the development of low-cost services in this corridor. Similarly, freight traffic was only 15 percent of the level forecast by the concessionaire. The low freight traffic was primarily due to:

- An infrastructure limit on track access in Spain, as a large portion of freight traffic requires a change of gauge between the two countries
- A lack of powerful, interoperable locomotives for the route

Due to these issues, most of the international traffic has been carried on the old (existing) rail line. Given the poor performance of the new line, TP Ferro was unable to repay its debt and it commenced insolvency processes.

The concession agreement covered the actions to be taken in the case of bankruptcy of the concessionaire. The two governments were responsible for ensuring a continuous service. When TP Ferro became insolvent, the operation of the line was awarded to two infrastructure managers (one Spanish, ADIF, and one French, SNCF Réseau). Furthermore, the two governments were responsible for repaying the non-performing loans and for compensating the shareholders for their contributions in equity that had not been recovered by the revenues of the company.

## 6.6 Categories of Governance Models: Initial Issues

Based on the case studies summarized above and considering the range of financing and delivery models described in Section 6.2, some common features and initial issues were identified for four broad categories of governance models. Most of the governance models outlined in this section are not specific to any financing solution for the construction phase of the project. The exception is the P3/Private Finance model, which represents a combined financing and governance model, where the private sector is involved in financing the project.

This section discusses these broad categories and initial issues, including consideration of advantages and disadvantages of each type of model.

### 6.6.1 P3/Private Finance

Major rail projects often implement some form of P3 arrangement to involve the private sector in certain elements of the project. The project sponsor and public partner will typically aim to achieve the best technical solution using the least public funding. Therefore, the public authority will often seek to share its responsibilities for project delivery and project finance with a private partner. It is critical for the public partner to make sure the private partner selected can succeed in both areas when developing a P3 agreement.



The selected P3 structure needs to allocate risks to the party best able to bear them, which will depend on the type and scale of the project and the maturity of the market for each element of the project. For example, the rolling stock leasing market in the UK is now quite mature and stable, so UK government agencies can proceed with a P3 solution for procurement of new rolling stock with some confidence. In the U.S., the market is generally less mature (for projects promoted at the state level, at least), and so this element would typically be procured through other methods, with the public sector taking more risk.

P3 models also entail specific types of delivery risk, for example, the risk that the public sector is required to bail out a failed private sector provider if major risks occur. This scenario is illustrated by the France-Spain P3 line, where extremely low traffic compared to forecast led to the bankruptcy of the AssetsCo. P3 agreements and international agreements between countries should allow for this possibility and provide clauses to guarantee the operation of the service and other consequences of a bankruptcy of the infrastructure manager (such as re-tendering of the concession, management of the line during the transition, compensation to the different parties, etc.).

### 6.6.2 Single Country Delivery and Management for Operations

An agency based in a single country that provides services to or on behalf of other countries is a feasible option for operating cross-border high-speed rail services, irrespective of the financing model used for the construction phase. A version of this model is used for the current Amtrak Cascades service and has close analogues among the U.S. multi-state models considered in Section 6.3. Also, this governance model is used for delivery of rail services through the Gotthard tunnel through the Alps.

### 6.6.3 Joint Commission or Joint Project Company

Another popular model is forming a joint commission that will act as the delivery agency/regulator for the project, representing both countries. This model typically requires a formal agreement between the two countries that will identify the funding, powers, and responsibilities of the joint commission.

This model should ensure that the objectives of both countries are considered when planning and delivering the infrastructure project. The joint commission should have the capability to address issues and disputes such as cost-sharing; this issue proved important for the St. Lawrence Seaway. Establishing a joint commission can take time and may be complex, depending on differences in regulatory and governance frameworks. One way to potentially avoid this issue is to create a joint project company, where the two countries still have representatives and equity, but the regulatory and legal procedures are more straightforward.

### 6.6.4 Vertical Separation Models

In Europe, vertical separation is required for provision of rail services between the infrastructure manager and the (usually incumbent) operating company. Vertical separation is usually helpful for the development of competition and achieving more efficient railway systems. This model is illustrated by the London-Paris HSR route, where the infrastructure managers (HS1, Eurotunnel, and SNCF Réseau) are responsible for managing the assets (i.e., the track and associated infrastructure) and the OpCos (primarily Eurostar) are responsible for the operation and maintenance of train services. The revenue streams for the OpCos are primarily derived from farebox revenue while the revenue streams for the infrastructure managers from are track access charges from the OpCos. A similar structure has been developed for the KL-Singapore route. However, for the KL-Singapore HSR line, the infrastructure managers outsource the network management to an AssetsCo.

## 6.7 Study Findings

This section identified potential financing and governance models that should be considered for the Vancouver-Seattle-Portland UHSGT project and examined existing structures and models applied in practice on existing cross-border infrastructure and comparable international systems. The applicability of these models was assessed with reference to selected case studies.

As outlined in Section 6.2, there is a variety of financing and delivery arrangements that offer different profiles of risks and responsibilities between private and public partners. The current U.S.-Canada arrangements discussed in Section 6.4 demonstrate that the two countries are already cooperating effectively on other transportation and infrastructure projects, and have already developed solutions for some complex cross-border issues such as arrangements for Customs and Borders Protection.

To manage the cross-border issues and identify an appropriate governance and finance structure for the Vancouver-Portland UHSGT project, the regulatory environment and funding capability of each country should be assessed in more detail. Identifying the country-specific issues is a critical step in determining which governance structure and financing model is most appropriate to use for the project. As explained below, this would be a key area of focus for any future work.

## Next Steps - Recommendations

Successful development of UHSGT between Vancouver, BC, Seattle, and Portland, Oregon faces many challenges ahead related to technology choices, planning and permitting, funding and financing, navigating an international intergovernmental agreement to manage and oversee a complex project, and system construction and operation. These challenges can be overcome with sufficient preparation and commitments. To lay this groundwork, development of UHSGT in Cascadia will require further study to address informational gaps, and assess the practicality and business case for a project with higher resolution. A series of recommended action items are outlined below for consideration.

### 7.1 Cascadia Transportation System

- Perform a next phase corridor planning study to include:
  - A conceptual corridor design analysis (technology neutral) that would identify any specific issues that arise when using one technology over another.
  - Potential station locations and service scenarios relative to market demand.
  - International HSR projects and US/Canadian infrastructure projects including enterprise lessons learned and their application to this UHSGT corridor.
  - Transportation system market trends and projections including land use and congestion.
  - Operational models that enhance multimodal integration and increase transportation system efficiency.
  - Analysis of the economic environment and structural changes to the relationship between Cascadia sub-regions to accurately examine potential demand.

### 7.2 Ridership

- Enhance ridership evaluation to inform and support the corridor planning study that incorporates:
  - A better understanding of potential ridership origin and destination (O/D) and trip preference including demand elasticity by conducting a robust, corridor-wide travel survey and stated preference survey.
  - Advanced travel demand modeling between Vancouver-Seattle-Portland with more sophisticated capability than is available with CONNECT.
  - Optimizing service offering by examining tradeoffs of maximizing revenue vs. maximizing ridership.
  - Market share, including an estimate of latent demand and sensitivity to changes in congestion, fuel/energy and parking costs.

### 7.3 Governance and Economic Framework

- Set up an initial, informal U.S./Washington-Oregon and Canada/British Columbia governmental commission to assist in the planning of the next steps in this program, including determining by phase the formal institutional framework to progress this cross-border international program.

- Expand governance and economic framework of corridor planning (business case) study that examines:
  - Structural growth and shifts in the regional economy, which may be affected by changes in the US and Canadian economies (consistent with last sub-bullet under 7.1).
  - Benefit/cost analysis with emphasis on transportation costs of all modes, travel time savings, reliability, including congestion, health, safety, and environmental costs.
  - Public and private partnership scenarios.
  - Plausible economic impacts changes to sectors and industries over time.
  - Sensitivities to latest assumptions such as fuel/energy prices, and connected and autonomous vehicles.
  - Governance and regulatory structure conducive to moving regional priorities and the cross-border bi-national and bi-state program forward.

## 7.4 Funding and Financing

- Further evaluate funding and financing mechanisms to inform and support corridor business case study that looks at:
  - Risk analyses to assess optimum risk transfer and highest value of money (VfM).
  - Regulatory challenges and advancing investment opportunities such as infrastructure banks.
  - Applicability of alternative transportation funding mechanisms such as carbon fees.
  - Financial responsibilities and cost sharing model options.
  - Revenue and farebox recovery.

## 7.5 Stakeholder Involvement

- Strengthen focused involvement of key stakeholders who could help guide and advocate, and provide financial and additional resource assistance from public and private sectors to successfully develop and implement corridor planning and business case study.

## 7.6 Short-Term Rail Planning Consistent with the Longer-Term UHSGT program

- Conduct rail planning consistent with this study that includes an examination of the following
  - Steps required for a subsequent round of incremental improvements to the existing Pacific Northwest Rail Corridor.
  - The expansion of rail services, north from both Portland and Seattle to Vancouver, to determine right-of-way, geographic, railroad, or capacity limitations.
- In a separate but coordinated study/plan process, examine future rail service on the East-West Stampede Pass corridor from Seattle to Spokane.